

# C-more Operator Panels Overview

## Getting started

Installing the software and configuring the **C-more** panel is simple. You will need the following to successfully connect, configure and send a project to the panel:

- **C-more** HMI - 6in, 7in wide, 8in, 10in, 10in wide, 12in, 15in or EA9-RHMI
- **C-more** Programming Software, p/n EA9-PGMSW
- **C-more** programming cable, USB or Ethernet
- 12-24 VDC switching power supply or the optional **C-more** AC Power Adapter, p/n EA-AC
- Personal Computer - to run **C-more** programming software
- PLC communications cable (serial or Ethernet) to connect the **C-more** HMI to your controller

Part Number	Description	Price
<b>EA9-T6CL-R</b>	<i>C-more</i> EA9 series touch screen HMI, 6in color TFT LCD, 320 x 240 pixel, QVGA, LED backlight, supports (1) serial and (2) USB ports and (1) memory card slot.	\$534.00
<b>EA9-T6CL</b>	<i>C-more</i> EA9 series touch screen HMI, 6in color TFT LCD, 320 x 240 pixel, QVGA, LED backlight, supports (3) serial, (1) Ethernet and (2) USB ports, (1) memory card slot and (1) audio line out.	\$748.00
<b>EA9-T7CL-R</b>	<i>C-more</i> EA9 series touch screen HMI, 7in color TFT LCD, widescreen, 800 x 480 pixel, WVGA, LED backlight, supports (1) serial, (1) Ethernet and (2) USB ports and (1) memory card slot.	\$499.00
<b>EA9-T7CL</b>	<i>C-more</i> EA9 series touch screen HMI, 7in color TFT LCD, widescreen, 800 x 480 pixel, WVGA, LED backlight, supports (3) serial, (1) Ethernet and (2) USB ports, (1) memory card slot and (1) audio line out.	\$578.00
<b>EA9-T8CL</b>	<i>C-more</i> EA9 series touch screen HMI, 8in color TFT LCD, 800 x 600 pixel, SVGA, LED backlight, supports (3) serial, (1) Ethernet and (2) USB ports, (1) memory card slot and (1) audio line out.	\$1,069.00
<b>EA9-T10CL</b>	<i>C-more</i> EA9 series touch screen HMI, 10in color TFT LCD, 800 x 600 pixel, SVGA, LED backlight, supports (3) serial, (1) Ethernet and (2) USB ports, (1) memory card slot and (1) audio line out.	\$1,380.00
<b>EA9-T10WCL</b>	<i>C-more</i> EA9 series touch screen HMI, 10in color TFT LCD, widescreen, 1024 x 600 pixel, WSVGA, LED backlight, supports (3) serial, (1) Ethernet and (2) USB ports, (1) memory card slot and (1) audio line out.	\$733.00
<b>EA9-T12CL</b>	<i>C-more</i> EA9 series touch screen HMI, 12in color TFT LCD, 800 x 600 pixel, SVGA, LED backlight, supports (3) serial, (1) Ethernet and (2) USB ports, (2) memory card slots, (1) HDMI video out and (1) audio line out.	\$1,917.00
<b>EA9-T15CL-R</b>	<i>C-more</i> EA9 series touch screen HMI, 15in color TFT LCD, 1024 x 768 pixel, XGA, LED backlight, supports (1) serial, (1) Ethernet and (2) USB ports and (2) memory card slots.	\$1,391.00
<b>EA9-T15CL</b>	<i>C-more</i> EA9 series touch screen HMI, 15in color TFT LCD, 1024 x 768 pixel, XGA, LED backlight, supports (3) serial, (1) Ethernet and (2) USB ports, (2) memory card slots, (1) HDMI video out and (1) audio line out.	\$2,140.00
<b>EA9-RHMI</b>	<i>C-more</i> EA9 series headless HMI, supports (2) serial, (1) Ethernet, (2) USB ports and (1) HDMI audio/video out and (1) memory card slot.	\$409.00
<b>EA9-PGMSW</b>	<i>C-more</i> Windows programming software, CD or free download. For use with <i>C-more</i> EA9 series touch panels. Requires USB or Ethernet connection to touch panel.	\$11.00 on CD, or FREE download
<b>USB-CBL-AB3</b>	Programming cable, USB A to USB B, 3ft cable length. For use with <i>C-more</i> HMIs, Do-more and Productivity series CPUs and most USB devices.	\$8.50
<b>USB-CBL-AB6</b>	Programming cable, USB A to USB B, 6ft cable length. For use with <i>C-more</i> HMIs, Do-more and Productivity series CPUs and most USB devices.	\$11.00
<b>USB-CBL-AB10</b>	Programming cable, USB A to USB B, 10ft cable length. For use with <i>C-more</i> HMIs, Do-more and Productivity series CPUs and most USB devices.	\$25.50
<b>USB-CBL-AB15</b>	Programming cable, USB A to USB B, 15ft cable length. For use with <i>C-more</i> HMIs, Do-more and Productivity series CPUs and most USB devices.	\$29.00

# C-more Selection Guide & Specifications

Specification	Model	8" TFT color w/ full features	10" TFT color w/ full features	10" TFT color Widescreen w/ full features
<b>Part Number</b>		EA9-T8CL	EA9-T10CL	EA9-T10WCL
<b>Price</b>		\$1,069.00	\$1,380.00	\$733.00
<b>Display Actual Size and Type</b>		8.4" TFT color	10.4" TFT color	10.1" TFT color
<b>Display Viewing Area</b>		6.71" x 5.03" [170.4 mm x 127.8mm]	8.31" x 6.24" [211.2 mm x 158.4 mm]	8.77" x 4.93" [222.7 mm x 125.3 mm]
<b>Weight</b>		2.93 lb [1330g]	4.19 lb [1900g]	2.43 lb [1100g]
<b>Screen Pixel</b>		800 x 600 (SVGA)		1024 x 600 (WSVGA)
<b>Display Brightness</b>		310 nits (typ)	280 nits (typ)	240 nits (typ)
<b>LCD Panel Dot Pitch</b>		0.213 mm x 0.213 mm	0.264 mm x 0.264 mm	0.218 mm x 0.209 mm
<b>Color Scale</b>		65,536 colors		
<b>Backlight Average Lifetime*</b>		50,000 hours @ 25°C		
<b>Touch Panel Type**</b>		Four-wire analog resistive, single touch		
<b>Project Memory</b>		26MB		
<b>Number of Screens</b>		Up to 999 screens – limited by project memory		
<b>Realtime Clock</b>		Realtime clock built into panel, backed up for 30 days at 25°C		
<b>Calendar – Month / Day / Year</b>		Yes - monthly deviation 60sec (Reference)		
<b>Serial Port 1</b>		15-pin D-sub female – RS232C, RS-422/485		
<b>Serial Port 2</b>		3-wire terminal block – RS-485		
<b>Serial Port 3</b>		RJ-12 modular jack – RS-232C		
<b>USB Port – Type B</b>		USB 2.0 High speed (480 Mbps) Type B – Download/Program – Max. cable length 15-feet		
<b>USB Port – Type A</b>		USB 2.0 High speed (480 Mbps) Type A – for USB device options – Max. cable length 15-feet – Bus Power – Less than 200mA at 5VDC		
<b>Ethernet Port</b>		10/100 Base-T, auto MDI/MDI-X		
<b>Ethernet Port - Expansion Module</b>		EA-ECOM		
<b>Audio Line Out</b>		3.5 mm mini jack – requires amplifier and speaker(s)		
<b>Mic In (Future)</b>		3.5 mm mini jack		
<b>SD Card Slot</b>		1 slot supports max 2GB (SD,) max 32GB (SDHC)		
<b>HDMI Video Out</b>		N/A		
<b>Supply Power</b>		10.2-26.4 VDC Class 2, Use Class2 and SELV (Safety Extra-Low Voltage) Circuit and Limited Energy Circuit (LEC), or use the AC/DC Power Adapter, EA-AC, to power the touch panel from a 100-240 VAC, 50/60 Hz power source. Reverse Polarity Protected		
<b>Power Consumption</b>		18.0 W 1.50 A @ 12VDC 0.75 A @ 24VDC		17.0W 1.42A @ 12 VDC 0.71A @ 24 VDC
<b>Internal Fuse (non-replaceable)</b>		6.3 A		
<b>Altitude</b>		Up to 2000m (6562ft)		
<b>Operating Temperature</b>		0 to 50°C (32 to 122°F) Maximum surrounding air temperature rating: 50°C (122°F) IEC 60068-2-14 (Test Nb, Thermal Shock)		
<b>Storage Temperature</b>		-20 to +60°C (-4 to +140°F) IEC 60068-2-1 (Test Ab, Cold) IEC 60068-2-2 (Test Bb, Dry Heat) IEC 60068-2-14 (Test Na, Thermal Shock)		
<b>Humidity</b>		5-95% RH (non-condensing)		
<b>Environment</b>		For use in Pollution Degree 2 environment, no corrosive gases permitted		
<b>Noise Immunity</b>		(EN61131-2), EN61000-4-2 (ESD), EN61000-4-3 (RFI), EN61000-4-4 (FTB), EN61000-4-5 (Serge), EN61000-4-6 (Conducted) EN61000-4-8 (Power frequency magnetic field immunity) (Local Test) RFI, (145MHz, 440Mhz 10W @ 10cm), Impulse 1000V @ 1µs pulse		
<b>Withstand Voltage</b>		1000VAC, 1min. (FG to Power supply )		
<b>Insulation Resistance</b>		> 10M ohm @ 500VDC (FG to Power supply )		
<b>Vibration</b>		IEC60068-2-6 (Test Fc)		
<b>Shock</b>		IEC60068-2-27 (Test Ea)		
<b>Emission</b>		EN55011 Class A (Radiated RF emission)		
<b>Enclosure</b>		NEMA 250 type 4/4X indoor use only UL50 type 4X indoor use only IP-65 indoor use only (When mounted correctly)		
<b>Agency Approvals</b>		UL508, E157382 CE (EN61131-2), RoHS (2011/65/EU) CUL Canadian C22.2		

**NOTES:** \*The backlight average lifetime is defined as the average usage time it takes before the brightness becomes 50% of the initial brightness. The lifetime of the backlight depends on the ambient temperature. The lifetime will decrease under low or high temperature usage.

\*\*The touchscreen is designed to respond to a single touch. If it is touched at multiple points at the same time, an unexpected object may be activated.

# C-more 10" TFT Color Touch Panel - Full Model

## EA9-T10CL

C-more EA9 series touch screen interface panel, 10-inch color TFT (10.4 inch viewable screen), 64K colors, 800 x 600 pixel SVGA screen resolution, 800MHz CPU, 12-24 VDC powered, NEMA 4/4X, IP65 (when mounted correctly; for indoor use only), non-replaceable LED backlight. Includes (3) serial ports, USB 2.0 Type A and B ports and Ethernet port; supports SD memory card. Compatible with EA9-PGMSW programming software version 5.0 or later.

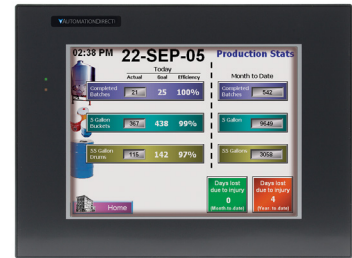

**\$1,380.00**

### Features



Function	Available
Ethernet	Yes
USB	Yes
SD Card	Yes
Audio Out	Yes
HDMI Video Out	No
Expansion Module	Yes

### Dimensions inches [mm]

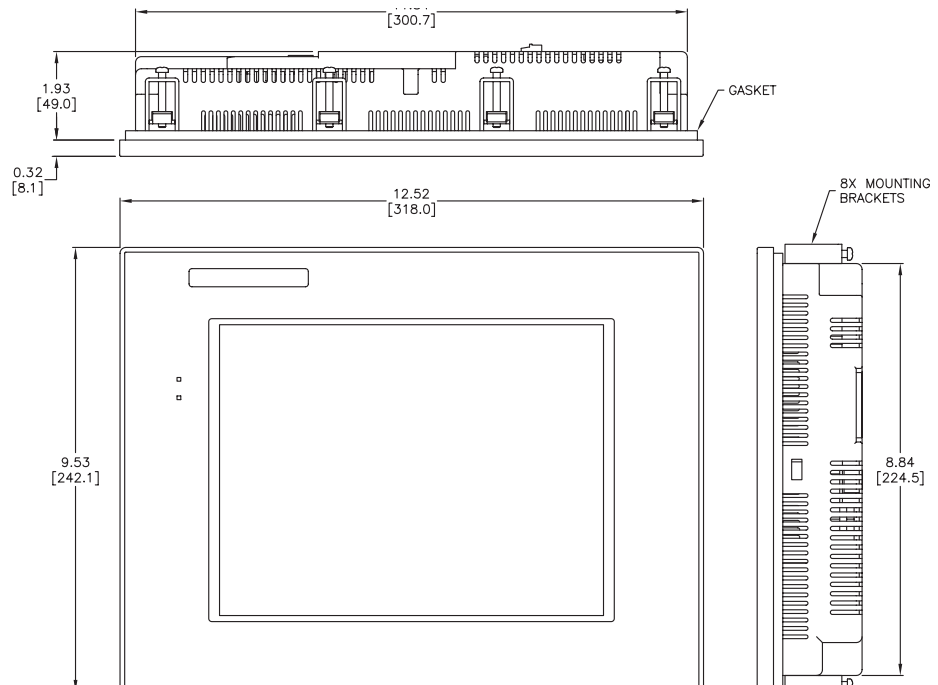

- 10.4" diagonal color TFT (Thin Film Transistor) LCD display with 64K colors
- 800 x 600 pixel resolution
- 280 NITS display brightness
- 50,000 hour average backlight half-life
- Analog resistive (1024 X 1024) touch screen allowing unlimited touch areas
- USB port B (program/download) and USB port A (USB device options)
- Ethernet 10/100 Base-T port (program/download & PLC communication)
- Expansion Module Support
- Use EA-ECOM for second Ethernet Port
- Remote Internet access
- Serial PLC interface (RS-232/422/485)
- One built-in SD memory card slot
- 12-24 VDC powered, 110VAC power adapter (optional)
- Audio Line Out, stereo - requires amplifier and speaker(s)
- 26MB project memory
- Data logging
- 0 to 50°C [32 to 122°F] operating temperature range
- NEMA 4/4X, IP65 compliant when mounted correctly, indoor use only
- Slim design save panel space
- UL, cUL & CE agency approvals
- 2-year warranty from date of purchase

See our website [www.AutomationDirect.com](http://www.AutomationDirect.com) for complete engineering drawings.

### Mounting Cutout

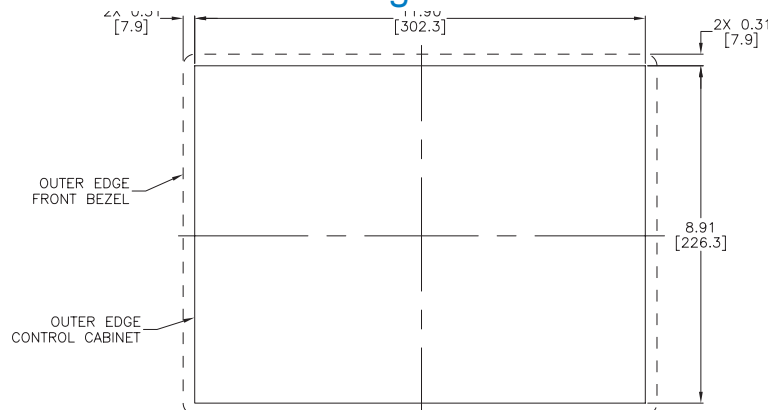

# C-more Communication Ports

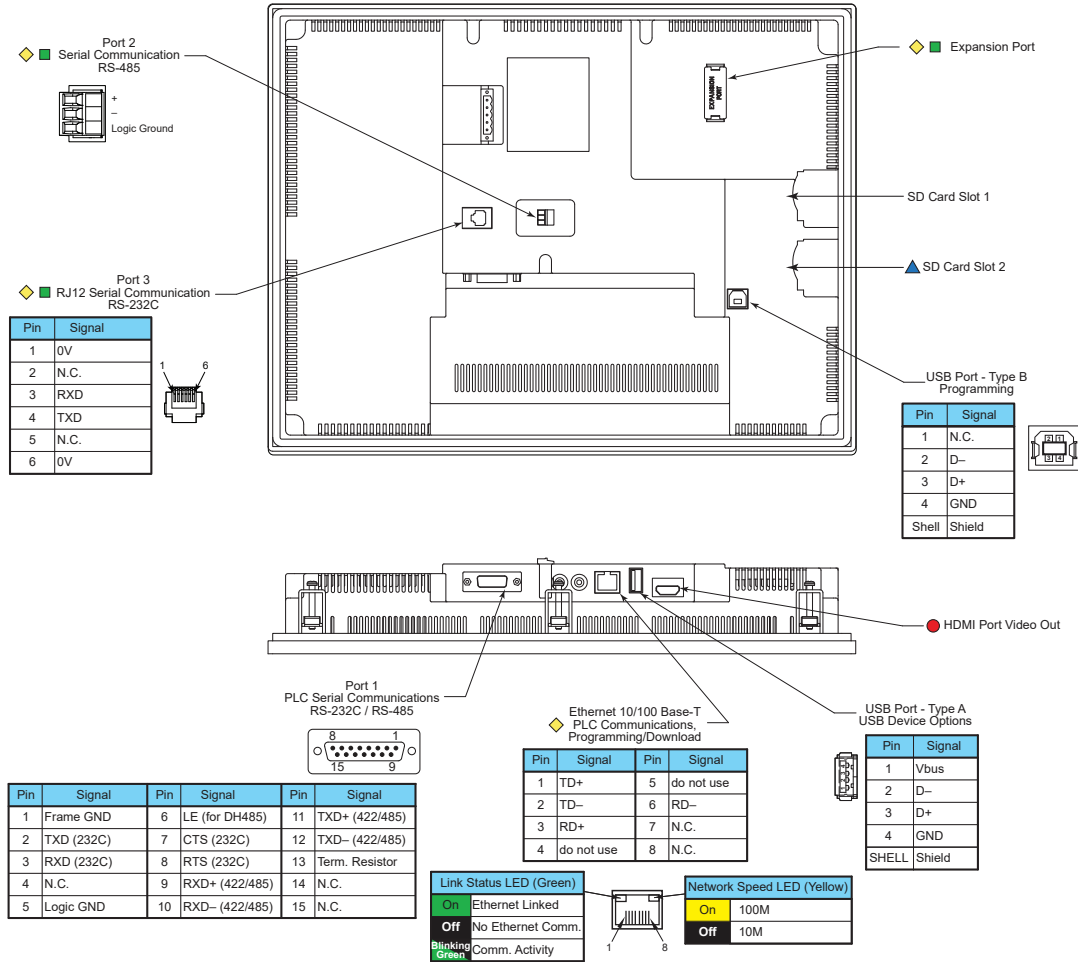

- Note: Device is not available on Base Feature touch panel EA9-T6CL-R
- Note: Device is not available on Base Feature touch panels EA9-T7CL-R and EA9-T15CL-R
- Note: Device is only available on touch panels EA9-T12CL and EA9-T15CL.
- Note: Device is only available on touch panels EA9-T12CL, EA9-T15CL and EA9-T15CL-R.

## Ethernet Port

The Ethernet port has several uses:

- Download program to panel
- Communicate to PLCs/PCs
- Send e-mail
- Access FTP server
- Act as a Web server
- Remote Internet access

The Ethernet port has an RJ-45 8-wire modular connector with green and yellow LEDs.

- The yellow LED indicates network speed – off for a 10 Mbps connection and illuminated for a 100 Mbps connection.
- The green LED indicates link status and illuminates when a link is established.

Note: EA6-T6CL-R does not include an Ethernet port, and does not have these capabilities.

## Expansion Port

The expansion port supports the EA-ECOM module to provide a second Ethernet Port for all full featured models.

## USB Port B

Program C-more via the USB programming port. It's fast and easy, with no baud rate settings, parity, or stop bits to worry about. We stock standard USB cables for your convenience. USB Port B can be used to upload or download projects to and from a PC.

## USB Port A

The Universal Serial Bus (USB) Port A is a standard feature on all models and can be used to connect various USB HID (Human Input Device) devices to the panel, such as the following:

- USB flash drives (USB-FLASH)
- USB keyboards
- USB barcode scanners
- USB card scanners

C-more can log data to the USB flash drive as well as load projects to the panel from the pen drive. You can also back up project files and panel firmware.

## Sound Interface (Audio Line Out)

When attached to an amplifier and speaker(s), C-more can play warning sounds or pre-recorded messages such as: "conveyor is jammed". C-more supports WAV type files. The output is stereo.

## Serial Port

**Port 1** - Connect to your serial controller network via Port 1. Port 1 is a 15-pin port that supports RS-232 or RS-422/485.

**Port 2** - Connect your RS-485 network via Port 2. Port 2 is provided with a 3-wire removable terminal block.

**Port 3** - Connect to your RS-232C device via Port 3. Port 3 is an RJ12 connection.

## HDMI Video Out

EA9-T12CL and EA9-T15CL include an HDMI Type A port to provide video output to a projector or remote monitor.

# C-more Communication Protocols & Cables

Compatibility Table				
PLC Family	Model	Protocols		
Allen-Bradley	MicroLogix 1000, 1100, 1200, 1400, 1500, SLC 5-01/02/03	DH485/AIC/AIC+		
	MicroLogix 1000, 1100, 1200, 1400 and 1500 SLC 5-03/04/05	DF1 Half Duplex; DF1 Full Duplex		
	ControlLogix™, CompactLogix™, FlexLogix™	DF1 Full Duplex		
	PLC-5	DF1 Full Duplex		
	ControlLogix, CompactLogix, FlexLogix - Tag Based	DF1 Half Duplex; DF1 Full Duplex		
	ControlLogix, CompactLogix, FlexLogix - Generic I/O Messaging	EtherNet/IP Server		
	ControlLogix, CompactLogix, FlexLogix - Tag Based	EtherNet/IP Client		
	Micrologix 1100, 1400 & SLC5/05, all via native Ethernet port	EtherNet/IP Client		
	MicroLogix 1000, 1100, 1200, 1400, 1500 & SLC 5-03/04/05, all via ENI Adapter	Modbus RTU		
	Micro 800 series	Modbus TCP		
Micro 800 series - Tag Based	DF1 Full Duplex EtherNet/IP Client			
<b>Modbus RTU</b>	Modbus RTU devices	Modbus RTU		
<b>Modbus TCP/IP</b>	Modbus TCP/IP devices	Modbus TCP/IP		
<b>GE</b>	90/30, 90/70, Micro 90, VersaMax Micro	SNPX		
	90/30, Rx3i	SRTP Ethernet		
<b>Mitsubishi</b>	FX Series	FX Direct		
	Q02, Q02H, Q06H, Q12H, Q25H	Q CPU		
	Q, QnA Serial	QnA Serial		
	Q, QnA Ethernet	QnA Ethernet		
<b>Omron</b>	C200 Adapter, C500	Host Link		
	CJ1/CS1 Serial, CJ1/CS1 Ethernet	FINs		
<b>Modicon</b>	984 CPU, Quantum 113 CPU, AEG Modicon Micro Series 110 CPU: 311-xx, 411-xx, 512-xx, 612-xx	Modbus RTU		
<b>Siemens</b>	S7-200 CPU, RS-485 Serial	PPI		
	S7-200 CPU, S7-300 CPU, S7-400, S7-1200 CPU, S7-1500; Ethernet	Ethernet ISO over TCP		
<b>Productivity Series</b>	all	AutomationDirect P3000 Serial AutomationDirect P3000 Ethernet		
<b>Do-more</b>	all	Do-more Serial Do-more Ethernet		
<b>CLICK</b>	all	AutomationDirect Modbus (CLICK)		
<b>DirectLOGIC</b>	DL05/DL06	all	K-Sequence <b>Direct NET</b> Modbus (Koyo addressing)	
		H0-ECOM/H0-ECOM100	<b>Direct LOGIC</b> Ethernet	
	DL105	all	K-Sequence	
			D2-230	K-Sequence
			D2-240	K-Sequence <b>Direct NET</b>
			D2-250/D2-250-1/D2-260/D2-262	K-Sequence <b>Direct NET</b> Modbus (Koyo addressing)
			D2-240/D2-250-1/D2-260 using D2-DCM	<b>Direct NET</b> Modbus (Koyo addressing)
			H2-ECOM/H2-ECOM100	<b>Direct LOGIC</b> Ethernet
	DL305	D3-330/330P (Requires the use of a Data Communications Unit)	D3-340	<b>Direct NET</b>
			D3-350	K-Sequence <b>Direct NET</b> Modbus (Koyo addressing)
			D3-350 using D3-DCM	<b>Direct NET</b> Modbus (Koyo addressing)
			D4-430	K-Sequence <b>Direct NET</b>
	DL405	All with D4-DCM	D4-440	K-Sequence <b>Direct NET</b>
			D4-450/D4-454	K-Sequence <b>Direct NET</b> Modbus (Koyo addressing)
			All with D4-DCM	<b>Direct NET</b> Modbus (Koyo addressing)
			H4-ECOM/H4-ECOM100	<b>Direct LOGIC</b> Ethernet
			H2-WinPLC (Think & Do) Live V5.2 or later and Studio any version	Think & Do Modbus RTU (serial port)
			H2-WinPLC (Think & Do) Live V5.5.1 or later and Studio V7.2.1 or later	Think & Do Modbus TCP/IP (Ethernet port)

Cable Description	Cable Part Number	Price
Communication cable, 15-pin male D-sub to 6-pin RJ12, shielded, 9.8ft/3m cable length. For use with <i>C-more</i> or <i>C-more</i> Micro panel and AutomationDirect PLCs with RJ12 ports.	<b>EA-2CBL</b>	\$21.50
Communication cable, 15-pin male D-sub to 15-pin D-sub HD15 male, shielded, 3m/9.8ft cable length. For use with <i>C-more</i> or <i>C-more</i> Micro panel and a DL06, D2-250(-1), D2-260 or D2-262 (bottom port) CPU.	<b>EA-2CBL-1</b>	\$22.00
Communication cable, 15-pin male D-sub to 4-pin RJ11, shielded, 3m/9.8ft cable length. For use with <i>C-more</i> or <i>C-more</i> Micro panel and a D3-340 CPU top or bottom port.	<b>EA-3CBL</b>	\$21.50
Communication cable, 15-pin male D-sub to 15-pin male D-sub, shielded, 3m/9.8ft cable length. For use with <i>C-more</i> or <i>C-more</i> Micro panel and a DL405 (top port) CPU.	<b>EA-4CBL-1</b>	\$21.50
Communication cable, 15-pin male D-sub to 25-pin male D-sub, shielded, 3m/9.8ft cable length. For use with <i>C-more</i> or <i>C-more</i> Micro panel and a D2-DCM, D3-232-DCU, D3-350 (bottom port) or DL405 (bottom port) CPU.	<b>EA-4CBL-2</b>	\$22.50
Communication cable, 15-pin male D-sub to 8-pin male mini DIN, shielded, 3m/9.8ft cable length. For use with <i>C-more</i> or <i>C-more</i> Micro panel and an Allen-Bradley Micrologix CPU.	<b>EA-MLOGIX-CBL</b>	\$33.00
Communication cable, 15-pin male D-sub to 9-pin female D-sub, shielded, 3m/9.8ft cable length. For use with <i>C-more</i> or <i>C-more</i> Micro panel and an Allen-Bradley SLC 5/03, 5/04 or 5/05 CPU with DF-1 port.	<b>EA-SLC-232-CBL</b>	\$21.50
Communication cable, 15-pin male D-sub to 25-pin male D-sub, 3m/9.8ft cable length. For use with <i>C-more</i> or <i>C-more</i> Micro panel and an Allen-Bradley PLC-5 CPU with a DF-1 port.	<b>EA-PLC5-232-CBL</b>	\$21.50
Communication cable, 15-pin male D-sub to 6-pin RJ45, shielded, 3m/9.8ft cable length. For use with <i>C-more</i> or <i>C-more</i> Micro panel and an Allen-Bradley SLC 5/01, 5/02 or 5/03 CPU with a DH485 port cable.	<b>EA-DH485-CBL</b>	\$21.00
Communication cable, 15-pin male D-sub to 15-pin male D-sub, shielded, 3m/9.8ft cable length. For use with <i>C-more</i> or <i>C-more</i> Micro and GE Fanuc Series 90/30 or 90/70 serial port.	<b>EA-90-30-CBL</b>	\$21.50
Communication cable, 15-pin male D-sub to 25-pin male D-sub, 3m/9.8ft cable length. For use with <i>C-more</i> or <i>C-more</i> Micro panel and a Mitsubishi FX Series CPU.	<b>EA-MITSU-CBL</b>	\$21.50
Communication cable, 15-pin male D-sub to 8-pin male mini DIN, shielded, 3m/9.8ft cable length. For use with <i>C-more</i> or <i>C-more</i> Micro panel and a Mitsubishi FX Series CPU.	<b>EA-MITSU-CBL-1</b>	\$21.50
Communication cable, 15-pin male D-sub to 25-pin male D-sub, shielded, 3m/9.8ft cable length. For use with <i>C-more</i> or <i>C-more</i> Micro panel and an Omron C200 or C500 CPU.	<b>EA-OMRON-CBL</b>	\$21.50

## Example Cables:



# C-more Computer Programming Connections

Using the **C-more** Programming Software EA9-PGMSW for project development, the HMI can be connected to a PC (personal computer) in one of several ways:

- Connect a USB Programming Cable such as (USB-CBL-AB15) from a USB port type A on the PC to the USB type B programming port on the C-more HMI. The USB connection is for direct connection only and does not support USB hubs.
- Connect the **C-more** HMI to a PC with a Cat5 Ethernet cable via an Ethernet switch. Multiple **C-more** HMIs can be programmed in this configuration.

Following are the minimum system requirements for running **C-more** Programming Software, p/n EA9-PGMSW, on a PC:

- USB or Ethernet connection to HMI (cables sold separately).
- Windows operating system - see automationdirect.com for specific operating system requirements.

## USB Programming Cable



Part No. USB-CBL-ABxx

USB Programming Cables		
Part Number	Length	Price
USB-CBL-AB3	3 feet	\$8.50
USB-CBL-AB6	6 feet	\$11.00
USB-CBL-AB10	10 feet	\$25.50
USB-CBL-AB15	15 feet	\$29.00

## Stride® Ethernet Switch



Message in from a device

Message is sent out only from the port connected to destination device

Part No. SE2-SW5U

\$78.00

### USB Connectivity

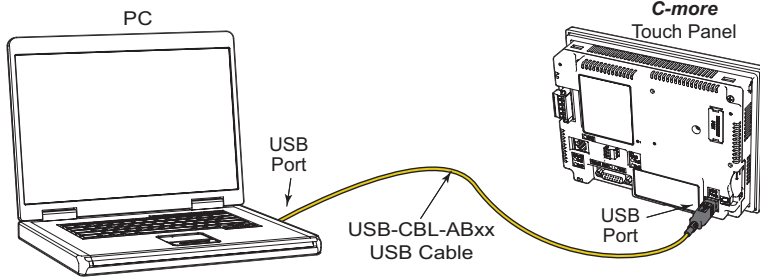

### Ethernet Connectivity via a Hub or Switch

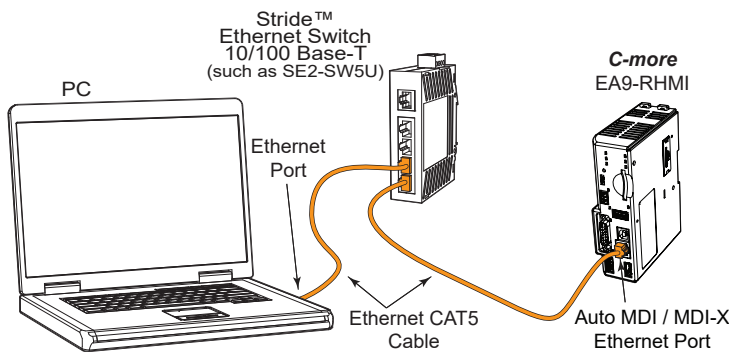

### Ethernet Direct Connection

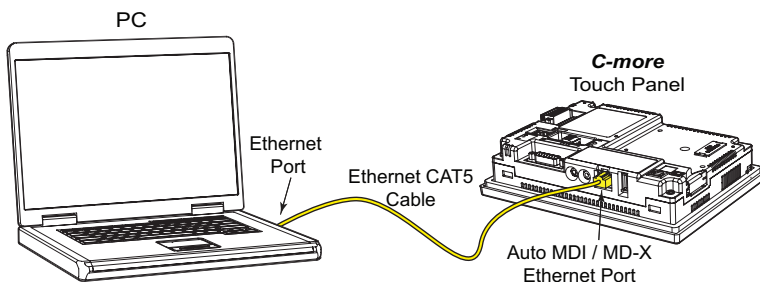

**NOTE: Regarding Ethernet access to a C-more HMI.**

If you intend to take advantage of the methods of remote access to the HMI, including the web server, PC remote access, FTP, iPhone or iPad app, you need to consider the security exposure in order to minimize the risks to your process and your C-more HMI.

Security measures may include password protection, changing the ports exposed on your network, including a VPN in your network, and other methods. Security should always be carefully evaluated for each installation.

# C-more Accessories

## Accessories

C-more touch panels can be enhanced with the accessories below:

Part Number	Description	Price
<b>EA-AC</b>	AC/DC power adapter, 24 VDC. For use with <i>C-more</i> EA7 and EA9 series touch panels.	\$80.00
<b>EA-6-COV2</b>	Screen protector, non-glare, 6in. Package of 3. For use with <i>C-more</i> and <i>C-more</i> Micro 6in panels.	\$40.50
<b>EA-7-COV2</b>	Screen protector, non-glare, 7in. Package of 3. For use with <i>C-more</i> 7in panels.	\$42.00
<b>EA-8-COV2</b>	Screen protector, non-glare, 8in. Package of 3. For use with <i>C-more</i> and <i>C-more</i> Micro 8in panels.	\$43.50
<b>EA-10-COV2</b>	Screen protector, non-glare, 10in. Package of 3. For use with <i>C-more</i> EA9-T10CL and <i>C-more</i> Micro EA3-T10CL HMIs.	\$49.00
<b>EA-10W-COV2</b>	Screen protector, non-glare, 10in. Package of 3. For use with <i>C-more</i> EA9-T10WCL widescreen HMI.	\$49.00
<b>EA-12-COV2</b>	Screen protector, non-glare, 12in. Package of 3. For use with <i>C-more</i> 12in panels.	\$50.00
<b>EA-15-COV2</b>	Screen protector, non-glare, 15in. Package of 3. For use with <i>C-more</i> 15in panels.	\$59.00
<b>EA-ECOM</b>	Communication expansion module, (1) RJ45 10/100 Mbps Ethernet port. For use with <i>C-more</i> Micro EA3 series 6in, 8in and 10in panels and all <i>C-more</i> HMIs except -R models.	\$54.00
<b>EA-COMCON-3</b>	DSUB port adapter, 15-pin male to 6-pole RS-422/485 terminal block, right angle cable entry. For use with <i>C-more</i> Micro EA1 series 4in and 6in HMIs, <i>C-more</i> Micro EA3 series 3in, 4in, and 6in HMIs, <i>C-more</i> EA9 6in and 7in HMIs.	\$45.50
<b>EA-COMCON-3A</b>	DSUB port adapter, 15-pin male to 6-pole RS-422/485 terminal block, straight cable entry. For use with <i>C-more</i> Micro EA1 series 3in with EA1-MG-SP1, <i>C-more</i> Micro EA3 series 8in and 10in HMIs, <i>C-more</i> EA9 8in, 10in, 12in and 15in HMIs.	\$21.00
<b>EA-SD-CARD</b>	SD memory card, 2GB, industrial.	\$106.00
<b>USB-FLASH</b>	SanDisk USB Flash drive, 32GB.	\$21.50

## Accessory Locations

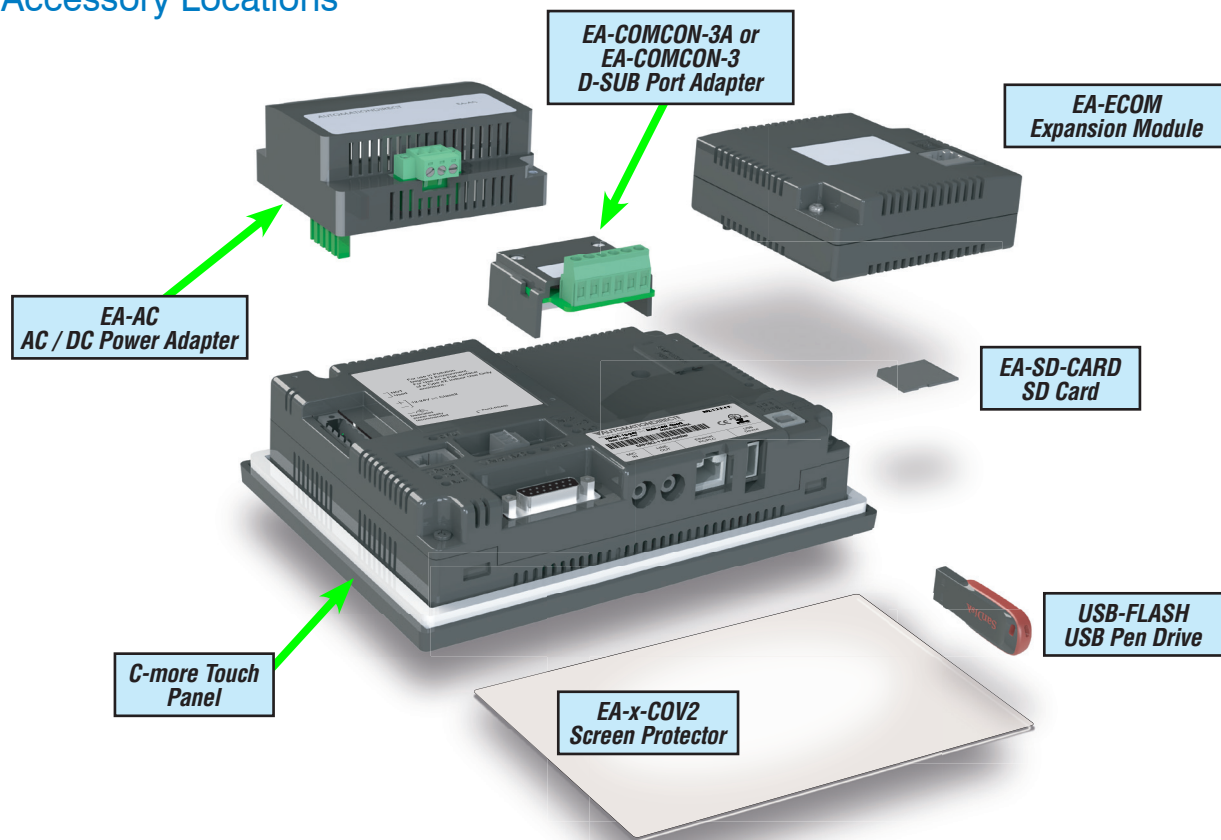

# C-more Accessories

## AC/DC Power Adapter

The optional *C-more* AC/DC Power Adapter can be used to power the *C-more* touch panels from a 100-240 VAC, 50/60 Hertz, voltage source. The adapter provides 24VDC @ 1.5 A to the touch panel's DC power connector and can be conveniently secured to the touch panel with two captive screws.

The adapter provides a power loss signal to the touch panel that causes the touch panel to stop writing data to SD memory devices providing a controlled shutdown for increased data logging reliability. EA-AC is not compatible with EA9-RHMI.

**Part No. EA-AC      \$80.00**



### Dimensions inches [mm]

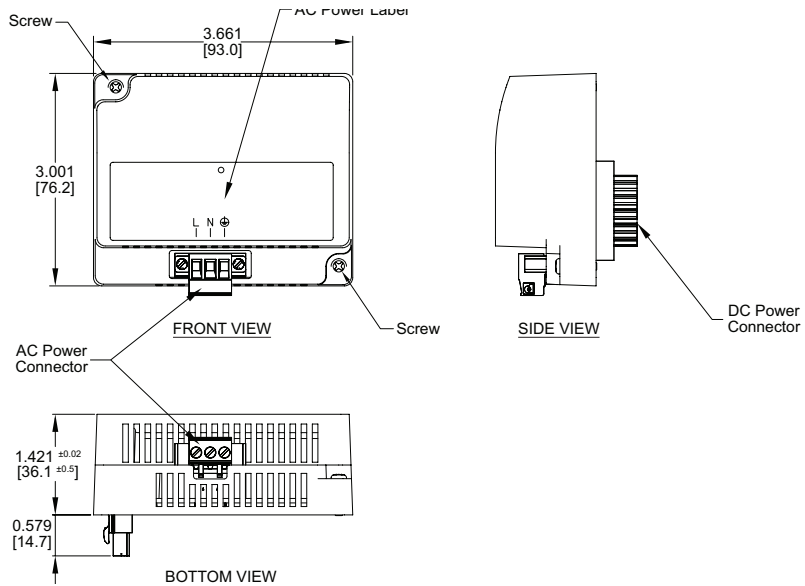

### Overall Panel Depth w/ EA-AC Installed

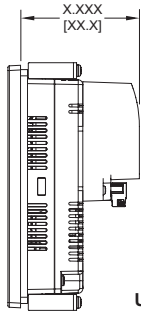

- EA9-T6CL-R = 2.99 [75.9]
- EA9-T6CL = 2.99 [75.9]
- EA9-T7CL-R = 2.99 [75.9]
- EA9-T7CL = 2.99 [75.9]
- EA9-T8CL = 3.51 [89.2]
- EA9-T10CL = 3.51 [89.2]
- EA9-T10WCL = 3.51 [89.2]
- EA9-T12CL = 3.35 [85.1]
- EA9-T15CL-R = 3.35 [85.1]
- EA9-T15CL = 3.35 [85.1]

Units: inches[mm]

AC/DC Power Adapter Specifications			
<b>Part Number</b>	EA-AC	<b>Short Circuit Protection</b>	85VAC: 2.6 A, 100VAC: 2.8 A, 264VAC: 3.9 A
<b>Input Voltage &amp; Frequency</b>	100-240 VAC +10% -15%; 50/60 Hertz	<b>Static Electricity Discharge Resistance</b>	Compliant with IEC61000-4-2, Contact: 4 kV, Air: 8 kV
<b>Wire</b>	24-14 AWG, 60 / 75°C Copper. Tighten to 72 oz-in (0.5 Nm)	<b>Agency Approvals</b>	UL508 - UL Recognized for use with <i>C-more</i> panels, cUL, CE, EMC EN61132-2
<b>Permissible Momentary Power Failure</b>	Within 40ms	<b>Environment</b>	For use in pollution degree 2 environment
<b>Input Power</b>	68VA or less	<b>Grounding</b>	Ground resistance: less than 100 ohm
<b>Operating Temperature Range</b>	0°C to 50°C [32 to 122°F] Maximum surrounding temperature rating, 50°C	<b>Dimensions - inches [mm]</b>	3.00" (H) x 3.66" (W) x 1.42" (D) [76.2 mm x 93.0 mm x 36.1 mm] (Excluding DC Power Connector.)
<b>Storage Temperature Range</b>	-20 to 60°C [-4 to 140°F]	<b>Weight</b>	6.13 oz. [175 g]
<b>Operating &amp; Storage Humidity</b>	10-85% RH (non-condensing)	<b>Cooling Method</b>	Natural convection
<b>Noise Immunity</b>	1000VAC p-p (Pulse width 1 μs, rise time: 1 ns), with proper ground connection on AC terminal block.	<b>Removable AC Power Connector (included)</b>	EA-AC-CON or DECA Switchlab MC101-508-03G Secured with (2) captive M2.5 screws, torque to 70 oz-in [0.5 Nm]
<b>Hi-Pot</b>	1000VAC, 1 minute, with proper ground connection on AC terminal block.	<b>Output Voltage and Ripple</b>	21.6 - 26.4 VDC, Ripple < 100 mV p-p
<b>Insulation Resistance</b>	500VDC, 10 M ohm or above, with proper ground connection on AC terminal block.	<b>Output Current</b>	Maximum 1.5 A
<b>Vibration</b>	Compliant with IEC61131-2	<b>Inrush Current</b>	For 100VAC: 15A, 3ms or less For 240VAC: 20A, 3ms or less
<b>Shock</b>	Pulse shape: Sine half wave, Peak acceleration: 147 m/s <sup>2</sup> (15 G), X, Y, Z: 3 directions, 2 times each	<b>Mounting to Touch Panel</b>	Secure with (2) spring loaded captive M3-20 screws, torque to 50 oz-in [0.35 Nm]
<b>Thermal Protection</b>	140°C [284°F], with autorecovery	<b>Recommended External Fuse</b>	3.0A (ADC p/n: MDL3)



# C-more Accessories

## SD Card

### EA-SD-CARD

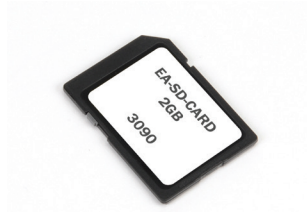

**\$106.00**

SD memory card for non-volatile storage, 2GB industrial grade. 85° C maximum operating temperature makes it suitable for data logging in industrial applications. Recommended for *C-more* EA9 series. The EA-SD-CARD utilizes SLC technology so it is the fastest option for writing and storing data. If logged data is saved to external memory, AutomationDirect recommends using an EA-SD-CARD.

SLC Flash memory utilized by EA-SD-CARD has the advantage of being the most accurate flash memory type when reading and writing data. SLC Flash has the longest lifespan of flash types and can operate in a broader temperature range than other types.

EA-SD-CARD with SLC Flash memory is recommended for industrial workloads that require heavy read / write cycles.

EA-SD-CARD Specifications	
<b>Operating Temperature</b>	0 to 70°C (32 to 158°F)
<b>Humidity</b>	20 to 85% (non-condensing)
<b>Capacity</b>	2GB
<b>Speed Modes</b>	High-Speed Normal-Speed
<b>Interface</b>	SD Memory Card Specification Ver. 3.0
<b>Speed Class</b>	Class 6

## USB Flash Drive

### USB-FLASH



**\$21.50**

USB flash drive for non-volatile storage, 32GB. Recommended for the *C-more* EA9 series touch panels.

# C-more Accessories

## D-SUB 15-pin to Terminal Block Adapter - Right Angle

The EA-COMCON-3 adapter plugs into the 15-pin serial port on the rear of a panel to allow wire terminal connections for an RS-422/RS-485 communication cable. Compatible with all *C-more* EA7 series panels, EA9-T6CL(-R) panels, EA9-T7CL(-R) panels and *C-more* Micro 4" and 6" panels. UL Recognized

**Part No.**  
**EA-COMCON-3**



**\$45.50**

### Dimensions

Units: inches [mm]

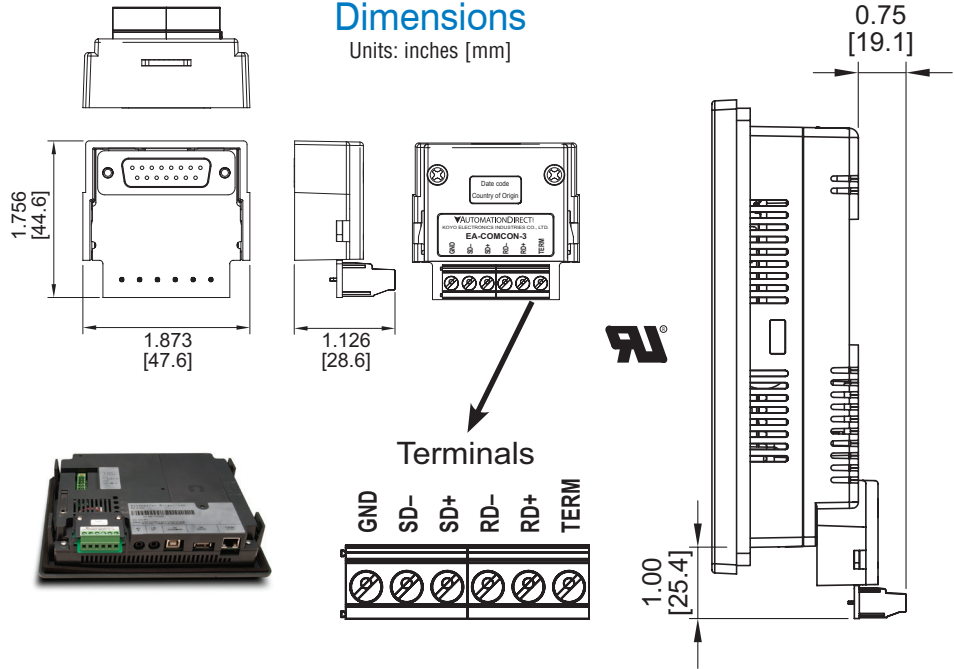

## D-SUB 15-pin to Terminal Block Adapter - Straight Through

The EA-COMCON-3A adapter plugs into the 15-pin serial port on the rear of a panel to allow wire terminal connections for an RS-422/RS-485 communication cable. Compatible with *C-more* EA9 series panels, EA9-RHMI, *C-more* Micro EA3-T8CL and EA3-T10CL panels and EA1-S3x with EA1-MG-SP1. Not compatible with EA9-T6CL(-R) and EA9-T7CL(-R) panels.

**Part No.**  
**EA-COMCON-3A**



**\$21.00**

### Dimensions

Units: inches [mm]

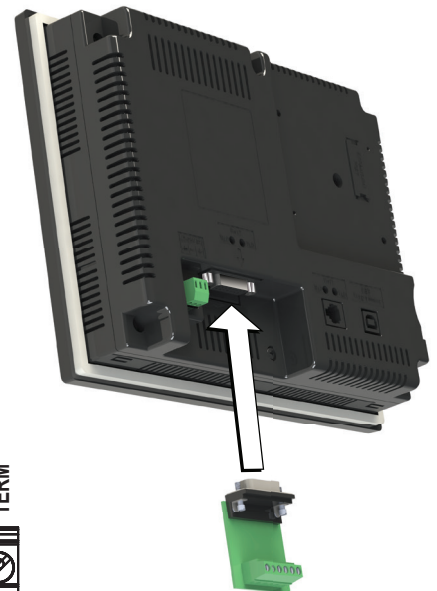
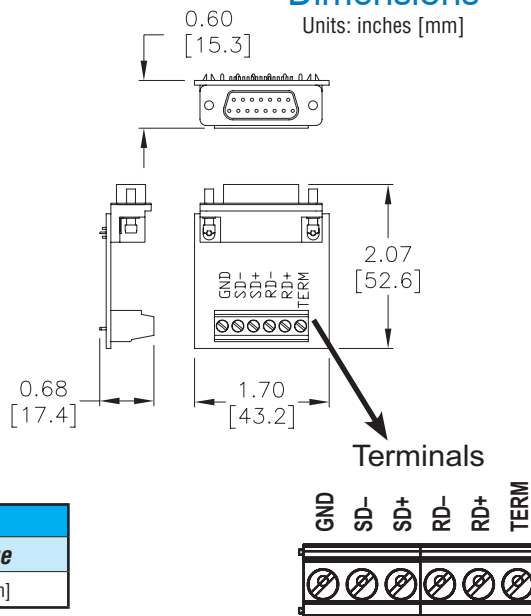

EA-COMCON-3(A) Wiring Specs	
Wire Size	Screw Torque
14-24 AWG	4.4 lb-in [0.5 Nm]

# C-more Accessories

## Non-glare Screen Covers (in packages of 3)

The non-glare screen covers are protective overlays used to protect the touch screen while helping to reduce the glare from external light sources.

**Part Numbers: EA-6-COV2, EA-7-COV2, EA-8-COV2, EA-10-COV2, EA-10W-COV2, EA-12-COV2 and EA-15-COV2**

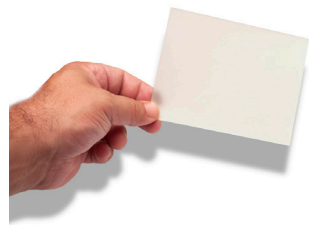

### Dimensions

inches [mm]

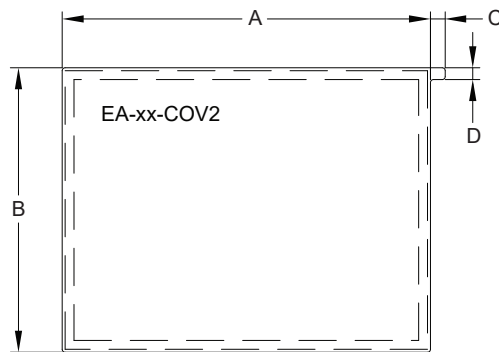

EA-6-COV2	\$40.50
EA-7-COV2	\$42.00
EA-8-COV2	\$43.50
EA-10-COV2	\$49.00
EA-10W-COV2	\$49.00
EA-12-COV2	\$50.00
EA-15-COV2	\$59.00

Non-glare Screen Covers Dimensions - inches [mm]				
Part Number	A	B	C	D
<b>EA-6-COV2</b>	4.91 [124.8]	3.80 [96.4]	0.197 [5.0]	0.157 [4.0]
<b>EA-7-COV2</b>	6.40 [162.6]	4.00 [101.5]		
<b>EA-8-COV2</b>	7.32 [185.8]	5.44 [138.2]		
<b>EA-10-COV2</b>	8.91 [226.2]	6.61 [168.0]		
<b>EA-10W-COV2</b>	9.23 [234.5]	5.38 [136.7]		
<b>EA-12-COV2</b>	10.26 [260.6]	7.64 [194.1]		
<b>EA-15-COV2</b>	12.56 [319.1]	9.37 [238.1]		

## Installation

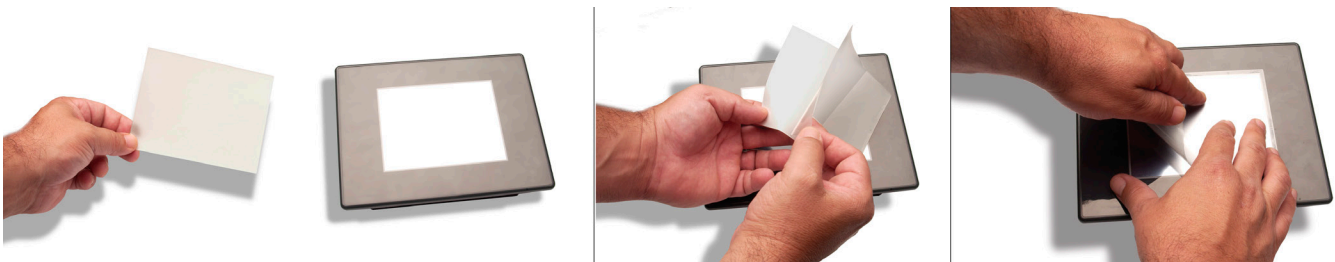

**NOTE:** The Protective Cover ships with a thin protective sheet on the face of the cover that needs to be carefully removed. If your panel is not clear, the protective sheet may not have been removed.

# Communication Expansion Module

## EA-ECOM Ethernet Communication Module

The EA-ECOM communication module is compatible with EA3 series **C-more** Micro 6-inch, 8-inch and 10-inch panels and most **C-more** panels. It adds an Ethernet (RJ45) port for programming and PLC communications at 10/100 Mbps. **C-more** Micro Software and firmware version 4.0 or later is required. **C-more** Software and firmware version 6.50 or later is required.

Part No. EA-ECOM



\$54.00

### Dimensions

Units: inches [mm]

PANEL CONNECTION

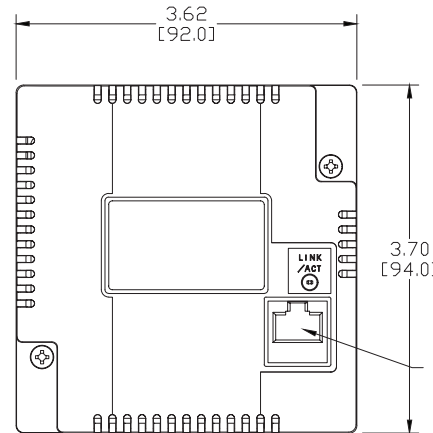
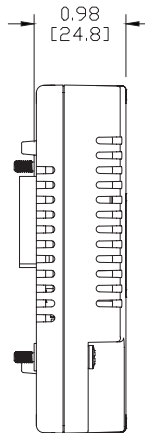
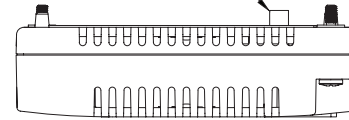

ETHERNET

### Ethernet Communication Interface Specifications

<b>Standard Specification</b>	Conforms to IEEE802.3
<b>Communication Speed</b>	10/100 Base-T (Automatic Negotiation)
<b>Cable Specification</b>	Category 5
<b>Auto MDI / MDI-X</b>	Yes
<b>Connector Type</b>	RJ45

### Communication Drivers

C-more	C-more Micro
Supports all C-more Ethernet drivers	AutomationDirect Productivity Series Ethernet
	AutomationDirect Do-more / BRX Ethernet
	AutomationDirect CLICK Ethernet
	AutomationDirect ECOM Ethernet
	Modbus TCP/IP
	Allen-Bradley EtherNet/IP (Client) SLC5/05
	Allen-Bradley EtherNet/IP (Client) ENI Adapter
	Allen-Bradley EtherNet/IP (Client) MicroLogix 1100/1400
	Allen-Bradley EtherNet/IP (Client) control/CompactLogix (SLC Mapping only)



Link Status LED (Green)	
On	Ethernet Linked
Off	No Ethernet Comm.
Blinking Green	Comm. Activity







### EA-ECOM Specifications

Part Number	EA-ECOM
<b>Operating Temperature</b>	0 to 50 °C (32 to 122 °F) Maximum surrounding air temperature rating: 50 °C
<b>Storage Temperature</b>	-20 to +60 °C (-4 to +140 °F)
<b>Humidity</b>	5-95% RH (non-condensing)
<b>Environmental Air</b>	For use in pollution degree 2 environment
<b>Vibration</b>	IEC60068-2-6 (Test Fc), 5-9 Hz: 3.5 mm amplitude, 9-150 Hz: 1.0G, sweeping, at a rate of 1 octave/min. (±10%), 10 sweep cycles per axis on each of 3 mutually perpendicular axes
<b>Shock</b>	IEC60068-2-27 (Test Ea), 15 G peak, 11ms duration, three shocks in each direction per axis, on 3 mutually perpendicular axes (total of 18 shocks)
<b>Noise Immunity</b>	NEMA ICS3-304 RFI, (145 MHz, 440 MHz 10 W @ 10 cm) Impulse 1000 V @ 1 µs pulse
<b>Emission</b>	EN55011 Class A (Radiated RF emission)
<b>Enclosure (panel door installation)</b>	NEMA 250 type 4/4X indoor use only UL50 type 4X indoor use only IP-65 indoor use only (When mounted correctly)
<b>Agency Approvals</b>	CE (EN61131-2), UL508, CUL Canadian C22.2 To obtain the most current agency approval information, see the Agency Approval Checklist section on the specific part number's web page
<b>Mounting Torque</b>	50 oz-in [0.35 N-m]
<b>Weight</b>	0.23 lb [105g]

# C-more Replacement Parts

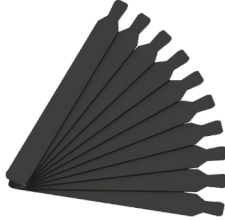
These replacement parts can be used to replace damaged, worn or lost *C-more* components.

## Replacement parts at a glance:

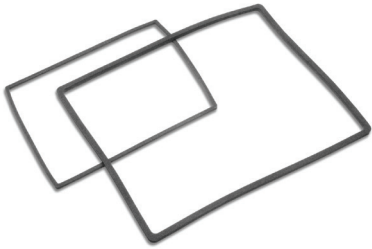
Part Number	Price		Description
<b>EA9-BRK</b>	\$28.50		Panel mounting brackets, replacement. Package of 8. For use with <i>C-more</i> EA9 series touch panels.
<b>EA9-LBL</b>	\$25.50		Blank label insert, replacement. Package of 10. For use with <i>C-more</i> EA9 series touch screen front bezel.
<b>EA9-3TB</b>	\$9.75		Pluggable terminal block, replacement, 3-pole. Package of 2. For use with 3-wire RS485 communications port on <i>C-more</i> EA9 series panels.
<b>CO-4TB</b>	\$7.75		CLICK terminal blocks, replacement, 4-pole. Package of 2. For use with CLICK PLCs. and <i>C-more</i> EA9-RHMI.
<b>EA-DC-CON</b>	\$15.50		DC 5-terminal power connector, replacement. For use with <i>C-more</i> EA7 and EA9 series touch panels.
<b>EA-AC-CON</b>	\$8.25		AC 3-terminal power connector, replacement. For use with <i>C-more</i> AC adapter (p/n EA-AC).
<b>EA9-15-GSK</b>	\$26.50		Panel mounting gasket, replacement. For use with <i>C-more</i> EA9 series 15in HMIs.
<b>EA9-12-GSK</b>	\$21.50		Panel mounting gasket, replacement. For use with <i>C-more</i> EA9-T12CL 12in touch panel.
<b>EA9-10W-GSK</b>	\$20.50		Panel mounting gasket, replacement. For use with <i>C-more</i> EA9-T10WCL 10in HMI.
<b>EA9-10-GSK</b>	\$20.50		Panel mounting gasket, replacement. For use with <i>C-more</i> EA9-T10CL 10in HMI.
<b>EA9-8-GSK</b>	\$18.50		Panel mounting gasket, replacement. For use with <i>C-more</i> EA9-T8CL 8in touch panel.
<b>EA9-6-GSK</b>	\$16.50		Panel mounting gasket, replacement. For use with <i>C-more</i> EA9 series 6in and 7in touch panels.