

EAT•N FAZ-NA Miniature Circuit Breakers



Overview

Eaton FAZ-NA and FAZ-NA-L miniature circuit breakers offer optimum and efficient protection for branch and control circuits up to 63 amps. The FAZ-NA and FAZ-NA-L series is available with B, C or D trip characteristics in accordance with UL 489. These circuit breakers are current limiting, which means they interrupt fault currents within one half cycle of the fault. The FAZ-NA and FAZ-NA-L series units are DIN-rail mountable and can be used in feeder and branch circuit applications.

Listings

- UL Listed under UL 489
Category DIVQ File E235139
Busbar Accessory
Category NMTR2.E257181
Category DIHS E257181
Category NMTR E307559
- CSA 22.2, No. 5 File 204453
- CE LVD 2014/35/EU
- CE RoHS 2011/65/EU
- IEC/EN 60947-2



Features and Benefits

- Dual rated for AC or DC applications
- Complete range of UL 489 listed DIN rail mounted miniature circuit breakers up to 63 amp current rating
- Single-pole, two-pole and three-pole models
- Current limiting design provides fast short circuit interruption that reduces the let-through energy, which can damage the circuit
- Suitable for reverse feed applications
- Suitable for branch circuit device protection
- Thermal-magnetic overcurrent protection – three levels of short circuit protection, categorized by B, C and D curves
- **B-curve magnetic trip point:**
3 to 5 times the rated current, typically used for resistive loads such as conductors or heaters.
- **C-curve magnetic trip point:**
5 to 10 times the rated current, typically used for small transformers, pilot devices, etc.
- **D-curve magnetic trip point:**
10 to 20 times the rated current, typically used for transformers or very high inductive loads.
- Trip-free design – breaker cannot be defeated by holding the handle in the “ON” position
- Captive screws cannot be lost
- SWD (switching duty) rated circuit breaker – suitable for switching fluorescent lighting loads ($I_n \leq 20A$)
- Fulfills UL 489, CSA C22.2 No.5 and also IEC 60947-2 Standard
- Can also be used in applications for which UL 1077 or CSA C22.2 No.235 are also allowed
- Field installable shunt trip and auxiliary switch subsequent mounting
- Module width of only 17.7 mm [0.70 in] (per pole)
- Contact position indicator (red / green)
- 35mm DIN-rail mountable, utilizing spring clip

Applications

Feeder and Branch Circuit Protection

- PLC I/O points
- Motor control circuits
- Control instrumentation
- Power supplies
- Relays
- Convenience receptacle circuits (internal / external)
- Load circuits leaving the equipment (external)
- HACR Equipment (Heating Air Conditioning, Refrigeration)
- Computers
- UPS
- Power conditioners

EAT•N FAZ-NA Series Selection Guide



Single-Pole

FAZ-NA – Single-Pole 480/277 VAC Selection Guide						
Ampere Rating	B-Curve Part Number	Price	C-Curve Part Number	Price	D-Curve Part Number	Price
0.5	–		FAZ-C0P5-1-NA-SP	\$21.50	FAZ-D0P5-1-NA-SP	\$21.50
1	FAZ-B1-1-NA-SP	\$21.00	FAZ-C1-1-NA-SP	\$21.50	FAZ-D1-1-NA-SP	\$21.50
1.5	FAZ-B1P5-1-NA-SP	\$21.00	FAZ-C1P5-1-NA-SP	\$21.50	FAZ-D1P5-1-NA-SP	\$21.50
2	FAZ-B2-1-NA-SP	\$21.00	FAZ-C2-1-NA-SP	\$21.50	FAZ-D2-1-NA-SP	\$21.50
3	FAZ-B3-1-NA-SP	\$21.00	FAZ-C3-1-NA-SP	\$21.50	FAZ-D3-1-NA-SP	\$21.50
4	FAZ-B4-1-NA-SP	\$21.00	FAZ-C4-1-NA-SP	\$21.50	FAZ-D4-1-NA-SP	\$21.50
5	FAZ-B5-1-NA-SP	\$21.00	FAZ-C5-1-NA-SP	\$21.50	FAZ-D5-1-NA-SP	\$21.50
6	FAZ-B6-1-NA-SP	\$21.00	FAZ-C6-1-NA-SP	\$21.50	FAZ-D6-1-NA-SP	\$21.50
7	FAZ-B7-1-NA-SP	\$21.00	FAZ-C7-1-NA-SP	\$21.50	FAZ-D7-1-NA-SP	\$21.50
8	FAZ-B8-1-NA-SP	\$21.00	FAZ-C8-1-NA-SP	\$21.50	FAZ-D8-1-NA-SP	\$21.50
10	FAZ-B10-1-NA-SP	\$21.00	FAZ-C10-1-NA-SP	\$21.50	FAZ-D10-1-NA-SP	\$21.50
13	FAZ-B13-1-NA-SP	\$21.00	FAZ-C13-1-NA-SP	\$21.50	FAZ-D13-1-NA-SP	\$21.50
15	FAZ-B15-1-NA-SP	\$21.00	FAZ-C15-1-NA-SP	\$21.50	FAZ-D15-1-NA-SP	\$21.50
16	FAZ-B16-1-NA-SP	\$21.00	FAZ-C16-1-NA-SP	\$21.50	FAZ-D16-1-NA-SP	\$21.50
20	FAZ-B20-1-NA-SP	\$21.00	FAZ-C20-1-NA-SP	\$21.50	FAZ-D20-1-NA-SP	\$21.50
25	FAZ-B25-1-NA-SP	\$21.00	FAZ-C25-1-NA-SP	\$21.50	FAZ-D25-1-NA-SP	\$21.50
30	FAZ-B30-1-NA-SP	\$21.00	FAZ-C30-1-NA-SP	\$21.50	FAZ-D30-1-NA-SP	\$21.50
32	FAZ-B32-1-NA-SP	\$21.00	FAZ-C32-1-NA-SP	\$21.50	FAZ-D32-1-NA-SP	\$21.50



Two-Pole

FAZ-NA – Two-Pole 480/277 VAC Selection Guide						
Ampere Rating	B-Curve Part Number	Price	C-Curve Part Number	Price	D-Curve Part Number	Price
0.5	–		FAZ-C0P5-2-NA	\$42.00	FAZ-D0P5-2-NA	\$42.00
1	FAZ-B1-2-NA	\$41.00	FAZ-C1-2-NA	\$42.00	FAZ-D1-2-NA	\$42.00
1.5	FAZ-B1P5-2-NA	\$41.00	FAZ-C1P5-2-NA	\$42.00	FAZ-D1P5-2-NA	\$42.00
2	FAZ-B2-2-NA	\$41.00	FAZ-C2-2-NA	\$42.00	FAZ-D2-2-NA	\$42.00
3	FAZ-B3-2-NA	\$41.00	FAZ-C3-2-NA	\$42.00	FAZ-D3-2-NA	\$42.00
4	FAZ-B4-2-NA	\$41.00	FAZ-C4-2-NA	\$42.00	FAZ-D4-2-NA	\$42.00
5	FAZ-B5-2-NA	\$41.00	FAZ-C5-2-NA	\$42.00	FAZ-D5-2-NA	\$42.00
6	FAZ-B6-2-NA	\$41.00	FAZ-C6-2-NA	\$42.00	FAZ-D6-2-NA	\$42.00
7	FAZ-B7-2-NA	\$41.00	FAZ-C7-2-NA	\$42.00	FAZ-D7-2-NA	\$42.00
8	FAZ-B8-2-NA	\$41.00	FAZ-C8-2-NA	\$42.00	FAZ-D8-2-NA	\$42.00
10	FAZ-B10-2-NA	\$41.00	FAZ-C10-2-NA	\$42.00	FAZ-D10-2-NA	\$42.00
13	FAZ-B13-2-NA	\$41.00	FAZ-C13-2-NA	\$42.00	FAZ-D13-2-NA	\$42.00
15	FAZ-B15-2-NA	\$41.00	FAZ-C15-2-NA	\$42.00	FAZ-D15-2-NA	\$42.00
16	FAZ-B16-2-NA	\$41.00	FAZ-C16-2-NA	\$42.00	FAZ-D16-2-NA	\$42.00
20	FAZ-B20-2-NA	\$41.00	FAZ-C20-2-NA	\$42.00	FAZ-D20-2-NA	\$42.00
25	FAZ-B25-2-NA	\$41.00	FAZ-C25-2-NA	\$42.00	FAZ-D25-2-NA	\$42.00
30	FAZ-B30-2-NA	\$41.00	FAZ-C30-2-NA	\$42.00	FAZ-D30-2-NA	\$42.00
32	FAZ-B32-2-NA	\$41.00	FAZ-C32-2-NA	\$42.00	FAZ-D32-2-NA	\$42.00

Note: Eaton product part numbers will contain a [.] instead of [P] and a [/] instead of a [-]. Example: FAZ-C0P5-3-NA = FAZ-C0.5/3-NA

Note: Eaton parts available for sale to North America locations only.

EATON FAZ-NA Series Selection Guide



Three-Pole

FAZ-NA – Three-Pole 480/277 VAC Selection Guide						
Ampere Rating	B-Curve Part Number	Price	C-Curve Part Number	Price	D-Curve Part Number	Price
0.5	–		FAZ-C0P5-3-NA	\$65.00	FAZ-D0P5-3-NA	\$65.00
1	FAZ-B1-3-NA	\$63.00	FAZ-C1-3-NA	\$65.00	FAZ-D1-3-NA	\$65.00
1.5	FAZ-B1P5-3-NA	\$63.00	FAZ-C1P5-3-NA	\$65.00	FAZ-D1P5-3-NA	\$65.00
2	FAZ-B2-3-NA	\$63.00	FAZ-C2-3-NA	\$65.00	FAZ-D2-3-NA	\$65.00
3	FAZ-B3-3-NA	\$63.00	FAZ-C3-3-NA	\$65.00	FAZ-D3-3-NA	\$65.00
4	FAZ-B4-3-NA	\$63.00	FAZ-C4-3-NA	\$65.00	FAZ-D4-3-NA	\$65.00
5	FAZ-B5-3-NA	\$63.00	FAZ-C5-3-NA	\$65.00	FAZ-D5-3-NA	\$65.00
6	FAZ-B6-3-NA	\$63.00	FAZ-C6-3-NA	\$65.00	FAZ-D6-3-NA	\$65.00
7	FAZ-B7-3-NA	\$63.00	FAZ-C7-3-NA	\$65.00	FAZ-D7-3-NA	\$65.00
8	FAZ-B8-3-NA	\$63.00	FAZ-C8-3-NA	\$65.00	FAZ-D8-3-NA	\$65.00
10	FAZ-B10-3-NA	\$63.00	FAZ-C10-3-NA	\$65.00	FAZ-D10-3-NA	\$65.00
13	FAZ-B13-3-NA	\$63.00	FAZ-C13-3-NA	\$65.00	FAZ-D13-3-NA	\$65.00
15	FAZ-B15-3-NA	\$63.00	FAZ-C15-3-NA	\$65.00	FAZ-D15-3-NA	\$65.00
16	FAZ-B16-3-NA	\$63.00	FAZ-C16-3-NA	\$65.00	FAZ-D16-3-NA	\$65.00
20	FAZ-B20-3-NA	\$63.00	FAZ-C20-3-NA	\$65.00	FAZ-D20-3-NA	\$65.00
25	FAZ-B25-3-NA	\$63.00	FAZ-C25-3-NA	\$65.00	FAZ-D25-3-NA	\$65.00
30	FAZ-B30-3-NA	\$63.00	FAZ-C30-3-NA	\$65.00	FAZ-D30-3-NA	\$65.00
32	FAZ-B32-3-NA	\$63.00	FAZ-C32-3-NA	\$65.00	FAZ-D32-3-NA	\$65.00



Single-Pole

FAZ-NA and FAZ-NA-L Single-Pole 240VAC Selection Guide						
Ampere Rating	B-Curve Part Number	Price	C-Curve Part Number	Price	D-Curve Part Number	Price
0.5	–		FAZ-C0P5-1-NA-L-SP	\$14.50	FAZ-D0P5-1-NA-L-SP	\$14.50
1	FAZ-B1-1-NA-L-SP	\$14.50	FAZ-C1-1-NA-L-SP	\$14.50	FAZ-D1-1-NA-L-SP	\$14.50
1.5	FAZ-B1P5-1-NA-L-SP	\$14.50	FAZ-C1P5-1-NA-L-SP	\$14.50	FAZ-D1P5-1-NA-L-SP	\$14.50
2	FAZ-B2-1-NA-L-SP	\$14.50	FAZ-C2-1-NA-L-SP	\$14.50	FAZ-D2-1-NA-L-SP	\$14.50
3	FAZ-B3-1-NA-L-SP	\$14.50	FAZ-C3-1-NA-L-SP	\$14.50	FAZ-D3-1-NA-L-SP	\$14.50
4	FAZ-B4-1-NA-L-SP	\$14.50	FAZ-C4-1-NA-L-SP	\$14.50	FAZ-D4-1-NA-L-SP	\$14.50
5	FAZ-B5-1-NA-L-SP	\$14.50	FAZ-C5-1-NA-L-SP	\$14.50	FAZ-D5-1-NA-L-SP	\$14.50
6	FAZ-B6-1-NA-L-SP	\$14.50	FAZ-C6-1-NA-L-SP	\$14.50	FAZ-D6-1-NA-L-SP	\$14.50
7	FAZ-B7-1-NA-L-SP	\$14.50	FAZ-C7-1-NA-L-SP	\$14.50	FAZ-D7-1-NA-L-SP	\$14.50
8	FAZ-B8-1-NA-L-SP	\$14.50	FAZ-C8-1-NA-L-SP	\$14.50	FAZ-D8-1-NA-L-SP	\$14.50
10	FAZ-B10-1-NA-L-SP	\$14.50	FAZ-C10-1-NA-L-SP	\$14.50	FAZ-D10-1-NA-L-SP	\$14.50
13	FAZ-B13-1-NA-L-SP	\$14.50	FAZ-C13-1-NA-L-SP	\$14.50	FAZ-D13-1-NA-L-SP	\$14.50
15	FAZ-B15-1-NA-L-SP	\$14.50	FAZ-C15-1-NA-L-SP	\$14.50	FAZ-D15-1-NA-L-SP	\$14.50
16	FAZ-B16-1-NA-L-SP	\$14.50	FAZ-C16-1-NA-L-SP	\$14.50	FAZ-D16-1-NA-L-SP	\$14.50
20	FAZ-B20-1-NA-L-SP	\$14.50	FAZ-C20-1-NA-L-SP	\$14.50	FAZ-D20-1-NA-L-SP	\$14.50
25	FAZ-B25-1-NA-L-SP	\$14.50	FAZ-C25-1-NA-L-SP	\$14.50	FAZ-D25-1-NA-L-SP	\$14.50
30	FAZ-B30-1-NA-L-SP	\$14.50	FAZ-C30-1-NA-L-SP	\$14.50	FAZ-D30-1-NA-L-SP	\$14.50
32	FAZ-B32-1-NA-L-SP	\$14.50	FAZ-C32-1-NA-L-SP	\$14.50	FAZ-D32-1-NA-L-SP	\$14.50
35	FAZ-B35-1-NA-SP	\$21.00	FAZ-C35-1-NA-SP	\$21.50	FAZ-D35-1-NA-SP	\$21.50
40	FAZ-B40-1-NA-SP	\$21.00	FAZ-C40-1-NA-SP	\$21.50	FAZ-D40-1-NA-SP	\$21.50
50	FAZ-B50-1-NA-SP	\$21.00	FAZ-C50-1-NA-SP	\$21.00	–	
63	FAZ-B63-1-NA-SP	\$21.00	FAZ-C63-1-NA-SP	\$21.00	–	

Note: Eaton product part numbers will contain a [.] instead of [P] and a [/] instead of a [-]. Example: FAZ-C0P5-3-NA = FAZ-C0.5/3-NA

Note: Eaton parts available for sale to North America locations only.

EATON FAZ-NA Series Selection Guide



Two-Pole

FAZ-NA and FAZ-NA-L Two-Pole 240VAC Selection Guide						
Ampere Rating	B-Curve Part Number	Price	C-Curve Part Number	Price	D-Curve Part Number	Price
0.5	-		FAZ-C0P5-2-NA-L	\$30.00	FAZ-D0P5-2-NA-L	\$30.00
1	FAZ-B1-2-NA-L	\$30.00	FAZ-C1-2-NA-L	\$30.00	FAZ-D1-2-NA-L	\$30.00
1.5	FAZ-B1P5-2-NA-L	\$30.00	FAZ-C1P5-2-NA-L	\$30.00	FAZ-D1P5-2-NA-L	\$30.00
2	FAZ-B2-2-NA-L	\$30.00	FAZ-C2-2-NA-L	\$30.00	FAZ-D2-2-NA-L	\$30.00
3	FAZ-B3-2-NA-L	\$30.00	FAZ-C3-2-NA-L	\$30.00	FAZ-D3-2-NA-L	\$30.00
4	FAZ-B4-2-NA-L	\$30.00	FAZ-C4-2-NA-L	\$30.00	FAZ-D4-2-NA-L	\$30.00
5	FAZ-B5-2-NA-L	\$30.00	FAZ-C5-2-NA-L	\$30.00	FAZ-D5-2-NA-L	\$30.00
6	FAZ-B6-2-NA-L	\$30.00	FAZ-C6-2-NA-L	\$30.00	FAZ-D6-2-NA-L	\$30.00
7	FAZ-B7-2-NA-L	\$30.00	FAZ-C7-2-NA-L	\$30.00	FAZ-D7-2-NA-L	\$30.00
8	FAZ-B8-2-NA-L	\$30.00	FAZ-C8-2-NA-L	\$30.00	FAZ-D8-2-NA-L	\$30.00
10	FAZ-B10-2-NA-L	\$30.00	FAZ-C10-2-NA-L	\$30.00	FAZ-D10-2-NA-L	\$30.00
13	FAZ-B13-2-NA-L	\$30.00	FAZ-C13-2-NA-L	\$30.00	FAZ-D13-2-NA-L	\$30.00
15	FAZ-B15-2-NA-L	\$30.00	FAZ-C15-2-NA-L	\$30.00	FAZ-D15-2-NA-L	\$30.00
16	FAZ-B16-2-NA-L	\$30.00	FAZ-C16-2-NA-L	\$30.00	FAZ-D16-2-NA-L	\$30.00
20	FAZ-B20-2-NA-L	\$30.00	FAZ-C20-2-NA-L	\$30.00	FAZ-D20-2-NA-L	\$30.00
25	FAZ-B25-2-NA-L	\$30.00	FAZ-C25-2-NA-L	\$30.00	FAZ-D25-2-NA-L	\$30.00
30	FAZ-B30-2-NA-L	\$30.00	FAZ-C30-2-NA-L	\$30.00	FAZ-D30-2-NA-L	\$30.00
32	FAZ-B32-2-NA-L	\$30.00	FAZ-C32-2-NA-L	\$30.00	FAZ-D32-2-NA-L	\$30.00
35	FAZ-B35-2-NA	\$41.00	FAZ-C35-2-NA	\$42.00	FAZ-D35-2-NA	\$42.00
40	FAZ-B40-2-NA	\$41.00	FAZ-C40-2-NA	\$42.00	FAZ-D40-2-NA	\$42.00
50	FAZ-B50-2-NA	\$41.00	FAZ-C50-2-NA	\$41.00	-	
63	FAZ-B63-2-NA	\$41.00	FAZ-C63-2-NA	\$41.00	-	



Three-Pole

FAZ-NA and FAZ-NA-L Three-Pole 240VAC Selection Guide						
Ampere Rating	B-Curve Part Number	Price	C-Curve Part Number	Price	D-Curve Part Number	Price
0.5	-		FAZ-C0P5-3-NA-L	\$45.00	FAZ-D0P5-3-NA-L	\$45.00
1	FAZ-B1-3-NA-L	\$45.00	FAZ-C1-3-NA-L	\$45.00	FAZ-D1-3-NA-L	\$45.00
1.5	FAZ-B1P5-3-NA-L	\$45.00	FAZ-C1P5-3-NA-L	\$45.00	FAZ-D1P5-3-NA-L	\$45.00
2	FAZ-B2-3-NA-L	\$45.00	FAZ-C2-3-NA-L	\$45.00	FAZ-D2-3-NA-L	\$45.00
3	FAZ-B3-3-NA-L	\$45.00	FAZ-C3-3-NA-L	\$45.00	FAZ-D3-3-NA-L	\$45.00
4	FAZ-B4-3-NA-L	\$45.00	FAZ-C4-3-NA-L	\$45.00	FAZ-D4-3-NA-L	\$45.00
5	FAZ-B5-3-NA-L	\$45.00	FAZ-C5-3-NA-L	\$45.00	FAZ-D5-3-NA-L	\$45.00
6	FAZ-B6-3-NA-L	\$45.00	FAZ-C6-3-NA-L	\$45.00	FAZ-D6-3-NA-L	\$45.00
7	FAZ-B7-3-NA-L	\$45.00	FAZ-C7-3-NA-L	\$45.00	FAZ-D7-3-NA-L	\$45.00
8	FAZ-B8-3-NA-L	\$45.00	FAZ-C8-3-NA-L	\$45.00	FAZ-D8-3-NA-L	\$45.00
10	FAZ-B10-3-NA-L	\$45.00	FAZ-C10-3-NA-L	\$45.00	FAZ-D10-3-NA-L	\$45.00
13	FAZ-B13-3-NA-L	\$45.00	FAZ-C13-3-NA-L	\$45.00	FAZ-D13-3-NA-L	\$45.00
15	FAZ-B15-3-NA-L	\$45.00	FAZ-C15-3-NA-L	\$45.00	FAZ-D15-3-NA-L	\$45.00
16	FAZ-B16-3-NA-L	\$45.00	FAZ-C16-3-NA-L	\$45.00	FAZ-D16-3-NA-L	\$45.00
20	FAZ-B20-3-NA-L	\$45.00	FAZ-C20-3-NA-L	\$45.00	FAZ-D20-3-NA-L	\$45.00
25	FAZ-B25-3-NA-L	\$45.00	FAZ-C25-3-NA-L	\$45.00	FAZ-D25-3-NA-L	\$45.00
30	FAZ-B30-3-NA-L	\$45.00	FAZ-C30-3-NA-L	\$45.00	FAZ-D30-3-NA-L	\$45.00
32	FAZ-B32-3-NA-L	\$45.00	FAZ-C32-3-NA-L	\$45.00	FAZ-D32-3-NA-L	\$45.00
35	FAZ-B35-3-NA	\$63.00	FAZ-C35-3-NA	\$65.00	FAZ-D35-3-NA	\$65.00
40	FAZ-B40-3-NA	\$63.00	FAZ-C40-3-NA	\$65.00	FAZ-D40-3-NA	\$65.00
50	FAZ-B50-3-NA	\$63.00	FAZ-C50-3-NA	\$63.00	-	
63	FAZ-B63-3-NA	\$63.00	FAZ-C63-3-NA	\$63.00	-	

Note: Eaton product part numbers will contain a [.] instead of [P] and a [/] instead of a [-]. Example: FAZ-C0P5-3-NA = FAZ-C0.5/3-NA

Note: Eaton parts available for sale to North America locations only.

EATON FAZ-NA Series

Technical Specifications

FAZ-NA and FAZ-NA-L Miniature Circuit Breakers – UL/CSA				
		B-Curve	C-Curve	D-Curve
Short Circuit Trip Response		3-5 x I _n	5-10 x I _n	10-20 x I _n
Current Range		1-63 A	0.5-63 A	0.5-40 A
Maximum Voltage Ratings UL / CSA	0.5-32 A	277/480V VAC (FAZ-NA), 240VAC (FAZ-NA-L)		
	35-63 A	240VAC		
	Per pole	48VDC		
	2 poles in series	96VDC Max		
Thermal Tripping Characteristics	Single pole	40°C [104°F]		
	Multi-pole			
Short Circuit Ratings (@ maximum voltage)	1 pole	10kA Note: 14 kAIC at select amperages B and C curves (15-25 A) D curve (13-20 A)		
	2 pole			
	3 pole			
Rated Frequency		50/60 Hz		
Agency Approvals		UL File #E235139, CSA #204453		
Notes: Line voltage connection suitable for reverse feed				
To obtain the most current agency approval information, see the Agency Approval Checklist section on the specific part number's web page.				
FAZ-NA and FAZ-NA-L Miniature Circuit Breaker - IEC				
		B-Curve	C-Curve	D-Curve
Short Circuit Trip Response		3-5 x I _n	5-10 x I _n	10-20 x I _n
Current Range		1-63 A	0.5-63 A	0.5-40 A
Maximum Voltage Ratings - IEC/EN 60947-2	1 pole	240/415 VAC		
	2 pole / 3 pole			
	2 poles in series			
Thermal Tripping Characteristics	Single pole	30°C [86°F]		
	Multi-pole			
Interrupt Ratings (At Max Voltage)		15kA		
Rated Frequency		50/60 Hz		
General Specifications				
Lifespan / Endurance		≥20,000 (1 operation = ON/OFF)		
Operating Temperature		UL 489, CSA C22.2 No.5 = 40°C IEC 60947-2 = 30°C		
Shock (UL 489)		10g 20-25 ms		
Housing Material		Nylon		
Mounting Position		Vertical		
Weight	1 pole	0.3 lb (136g)		
	2 pole	0.6 lb (272g)		
	3 pole	0.9 lb (408g)		
Wire Size				
Ampere Rating		Conductor Size		
0.5 - 63		One wire	18 to 6 AWG (0.75 to 13 mm ²)	
		Two wires	18 to 10 AWG (0.75 to 5 mm ²)	
Note: Eaton does not recommend the use of wire ferrules or crimping terminals. The wire gauges are specified above and in the installation instructions included with each circuit breaker.				
Tightening Torque				
Conductor Size		Tightening Torque		
18-12 AWG		21 lb-in (2.4 N-m)		
10-8 AWG		25 lb-in (2.8 N-m)		
6AWG		36 lb-in (4.1 N-m)		

EAT•N FAZ-NA Series Technical Data

Let-Through Energy

- The X axis shows the prospective short-circuit current levels.
- The Y axis indicates the actual let-through values at those prospective fault ratings for each FAZ-NA device plotted.

As can be interpreted from the bend in the plotted curves, each device acts to limit the damaging let-through energy at those values of short-circuit current.

Characteristic C (0.5-20A), 277V

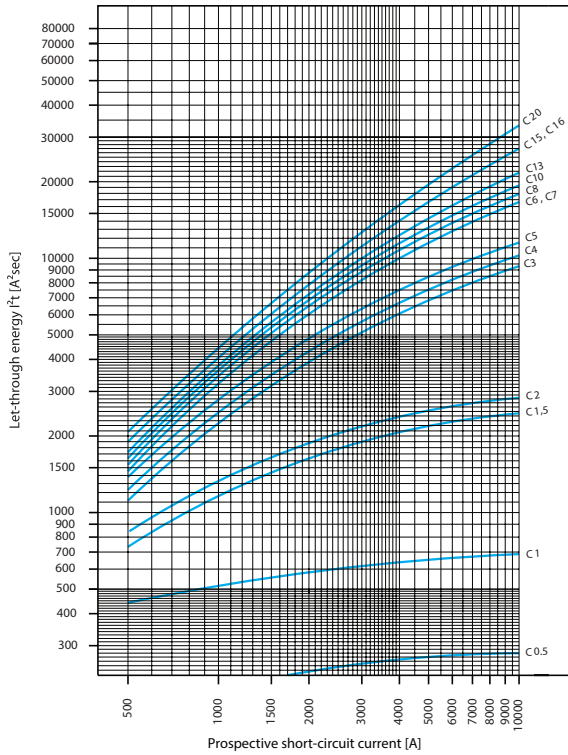

Characteristic C (25-40A), 240V

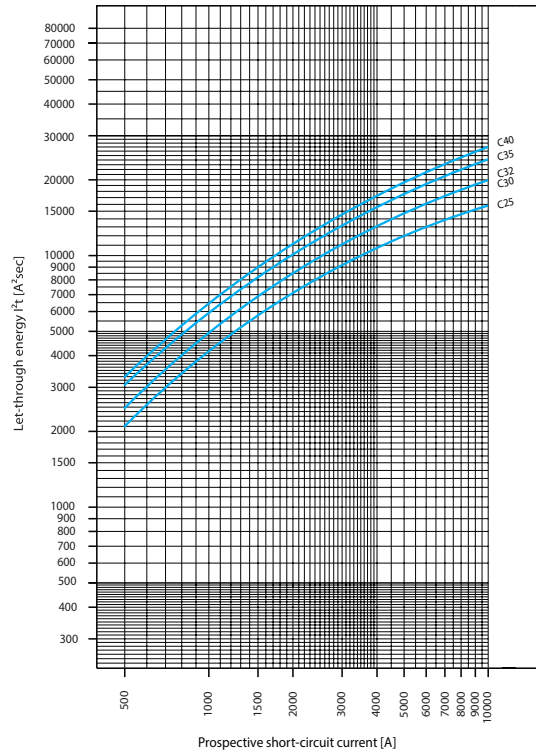

Characteristic D (0.5-20A), 277V

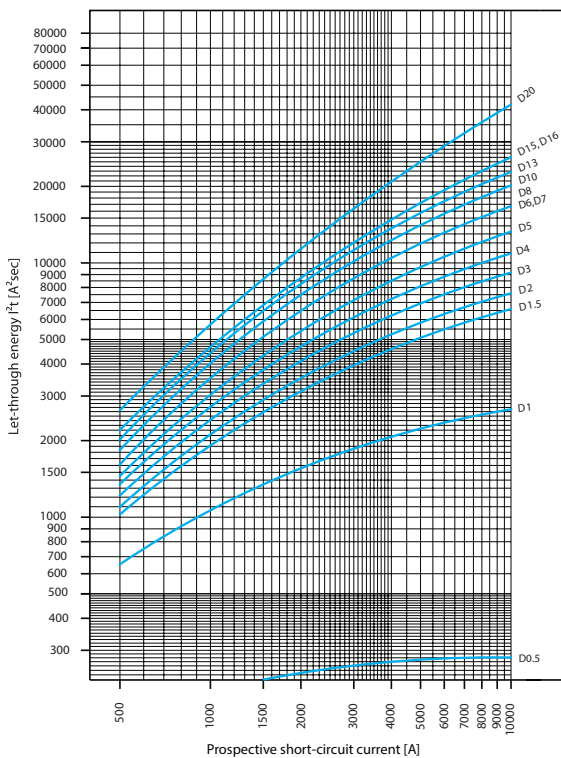

Characteristic D (25-40A), 240V

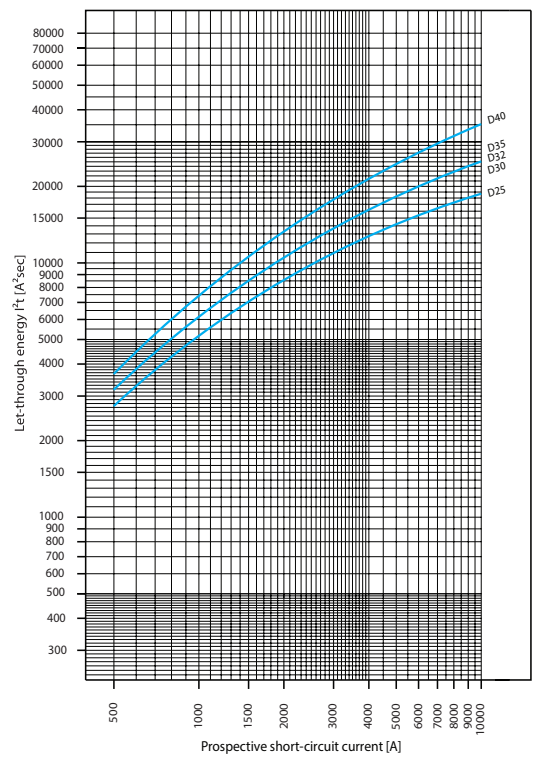

EAT•N FAZ-NA Series Technical Data

Let-Through Energy

- The X axis shows the prospective short-circuit current levels.
- The Y axis indicates the actual let-through values at those prospective fault ratings for each FAZ-NA device plotted.

As can be interpreted from the bend in the plotted curves, each device acts to limit the damaging let-through energy at those values of short-circuit current.

Characteristic B (1–32 A), 277 V

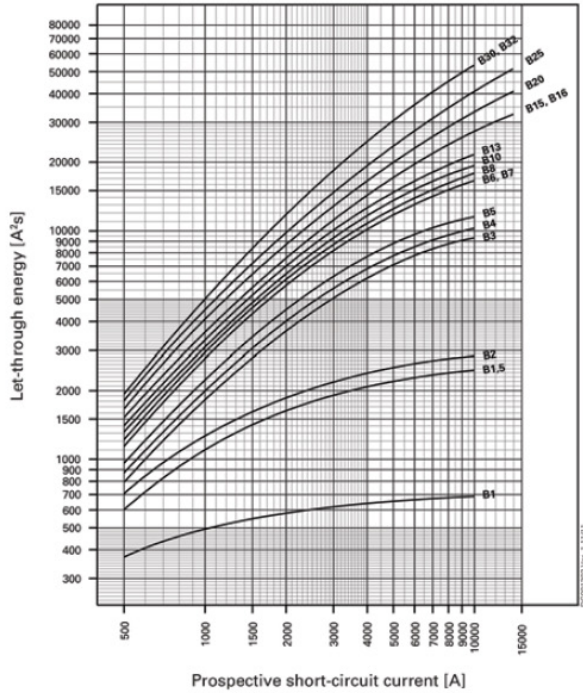

Characteristic B (35–63 A), 240 V

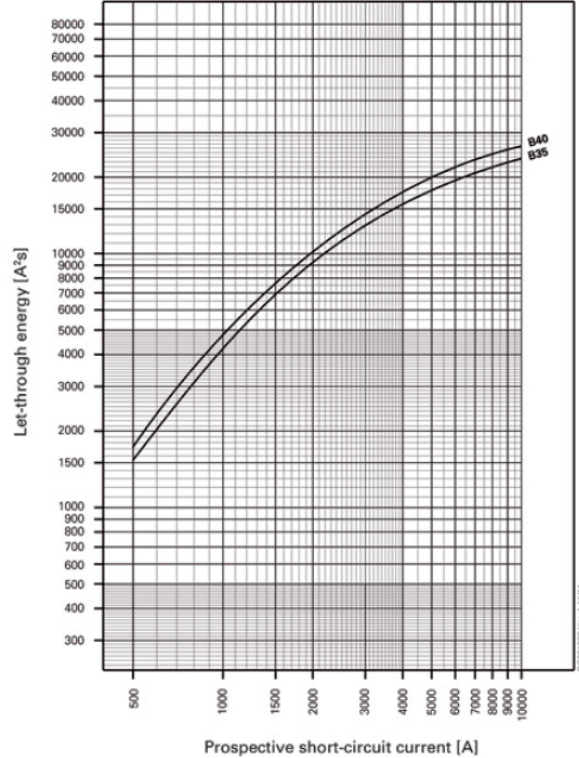

Characteristic C (35–63 A), 240 V

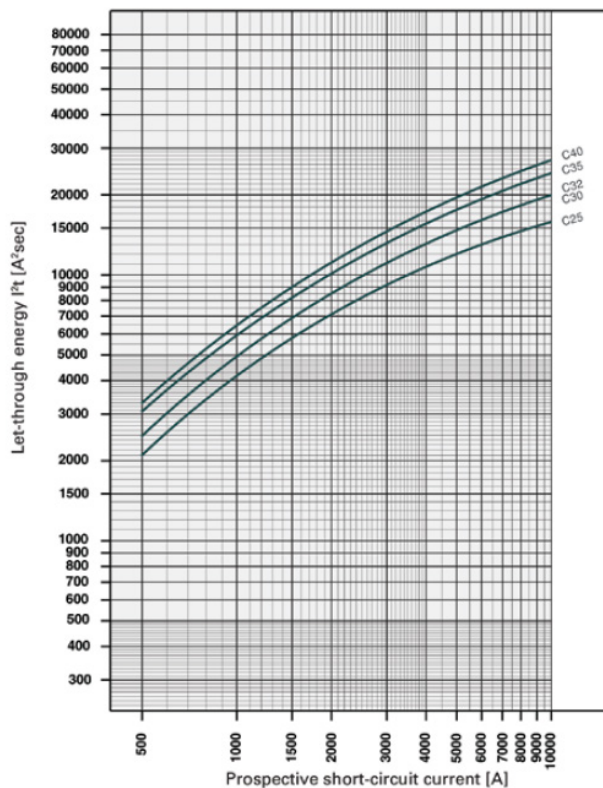

Characteristic D (35–63 A), 240 V

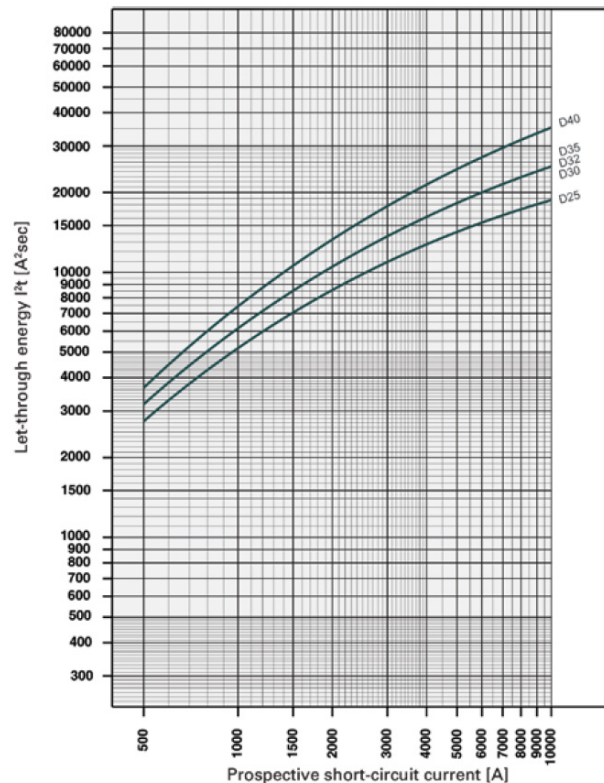

EAT•N FAZ-NA Series Technical Data

Power Loss at I_n

Power Loss at I_n			
Characteristic B			
I_n [A]	1p P[W]	2p P[W]	3p P[W]
0.5	-	-	-
1	1.1	2.2	3.4
1.5	2.2	4.4	6.6
2	1.4	2.8	4.3
3	2.1	4.2	6.4
4	1.4	2.9	4.3
5	1.8	3.7	5.5
6	1.7	3.5	5.2
7	2.0	4.0	6.0
8	2.0	3.9	5.9
10	1.8	3.6	5.3
13	2.4	4.7	7.1
15	1.9	3.8	5.8
16	2.1	4.3	6.4
20	2.9	5.8	8.7
25	3.1	6.2	9.3
30	3.0	6.0	9.0
32	3.4	6.8	10.2
35	4.0	8.1	12.1
40	4.0	8.1	12.1
50	4.4	8.8	13.2
63	5.5	11.0	16.5

Power Loss at I_n			
Characteristic C			
I_n [A]	1p P[W]	2p P[W]	3p P[W]
0.5	1.6	3.2	4.7
1	1.1	2.2	3.4
1.5	1.3	2.6	3.9
2	1.4	2.8	4.3
3	1.2	2.4	3.6
4	1.4	2.9	4.3
5	1.9	3.7	5.6
6	1.2	2.3	3.5
7	1.4	2.8	4.3
8	1.4	2.8	4.2
10	1.8	3.6	5.3
13	2.4	4.7	7.1
15	1.9	3.8	5.6
16	2.1	4.3	6.4
20	2.9	5.8	8.7
25	3.1	6.2	9.3
30	3.0	6.0	9.0
32	3.4	6.8	10.2
35	3.7	7.4	11.0
40	4.0	8.1	12.1
50	4.4	8.8	13.2
63	5.5	11.0	16.5

Power Loss at I_n			
Characteristic D			
I_n [A]	1p P[W]	2p P[W]	3p P[W]
0.5	1.6	3.2	4.8
1	0.8	1.5	2.3
1.5	1.0	2.1	3.1
2	1.0	2.1	3.1
3	1.2	2.4	3.6
4	1.4	2.9	4.3
5	1.5	2.9	4.4
6	1.2	2.3	3.5
7	1.4	2.8	4.3
8	1.2	2.4	3.7
10	1.5	3.0	4.5
13	2.0	4.1	6.1
15	1.5	3.1	4.6
16	1.7	3.5	5.2
20	1.8	3.7	5.5
25	2.6	5.1	7.7
30	2.7	5.4	8.1
32	3.1	6.2	9.3
35	3.8	7.6	11.3
40	3.9	7.8	11.6
50	-	-	-
63	-	-	-

Tripping Curves

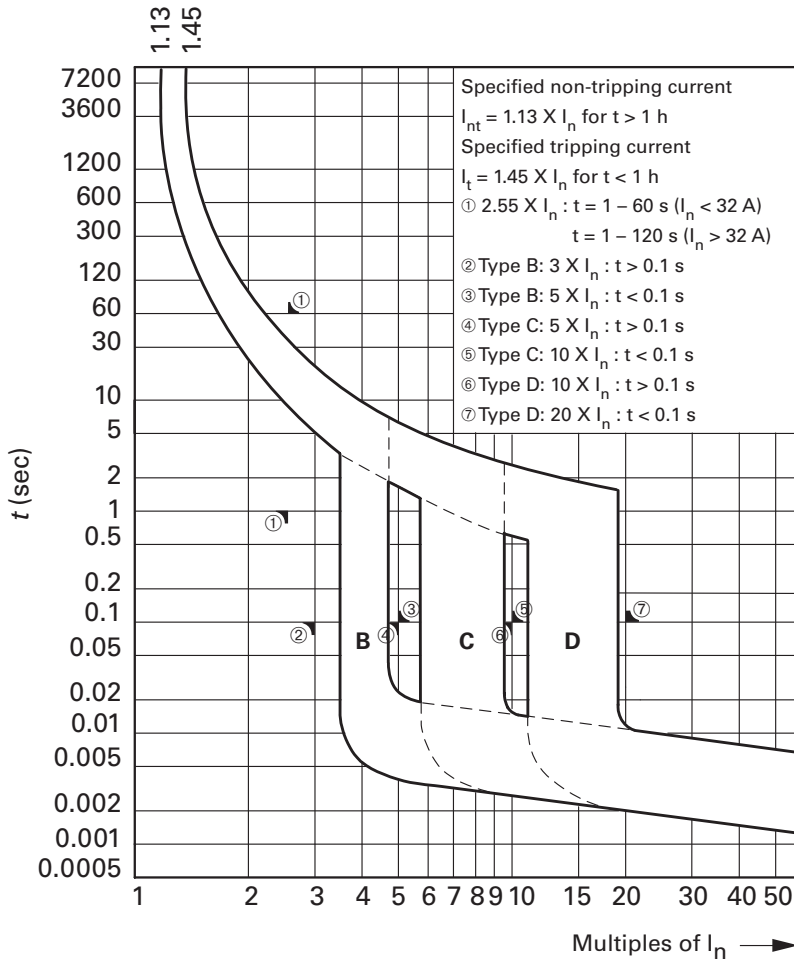

Please see our website www.AutomationDirect.com for complete engineering drawings. Dimensions are approximate. Not for construction purposes.

EAT•N FAZ-NA Series Technical Data

FAZ-NA Miniature Circuit Breakers Dimensions



EAT•N FAZ-NA Series Technical Data

Influence of Ambient Temperature T on Load Carrying Capacity								
Device Market Current Rating I_n (A) at 40°C	I_n (A) at Higher Ambient Temperature							
	15°C	20°C	25°C	30°C	40°C	50°C	55°C	60°C
0.5	0.6	0.5	0.5	0.5	0.5	0.5	0.5	0.5
1.0	1.1	1.1	1.1	1.0	1.0	1.0	0.9	0.9
1.5	1.7	1.6	1.6	1.6	1.5	1.4	1.4	1.4
2.0	2.2	2.2	2.1	2.1	2.0	1.9	1.9	1.8
3.0	3.3	3.2	3.2	3.1	3.0	2.9	2.9	2.8
4.0	4.4	4.3	4.2	4.2	4.0	3.8	3.8	3.7
5.0	5.5	5.4	5.3	5.2	5.0	4.8	4.7	4.6
6.0	6.6	6.5	6.4	6.2	6.0	5.8	5.6	5.5
7.0	7.7	7.6	7.4	7.3	7.0	6.7	6.6	6.4
8.0	8.8	8.6	8.5	8.3	8.0	7.7	7.5	7.4
10.0	11.0	10.8	10.6	10.4	10.0	9.6	9.4	9.2
13.0	14.3	14.0	13.8	13.5	13.0	12.5	12.5	12.0
15.0	16.5	16.2	15.9	15.6	15.0	14.4	14.1	13.8
16.0	17.6	17.3	17.0	16.6	16.0	15.4	15.0	14.7
20.0	22.0	21.6	21.2	20.8	20.0	19.2	18.8	18.4
25.0	27.5	27.0	26.5	26.0	25.0	24.0	23.3	23.0
30.0	33.0	32.4	31.8	31.2	30.0	28.8	28.2	27.6
32.0	35.2	34.6	33.9	33.3	32.0	30.7	30.1	29.4
35.0	38.5	37.8	37.1	36.4	35.0	33.6	32.9	32.2
40.0	44.0	43.2	42.4	41.6	40.0	38.4	37.6	36.8
50.0	55.0	54.0	53.0	52.0	50.0	48.0	47.0	46.0
63.0	69.3	68.0	66.8	65.5	63.0	60.5	59.2	58.0

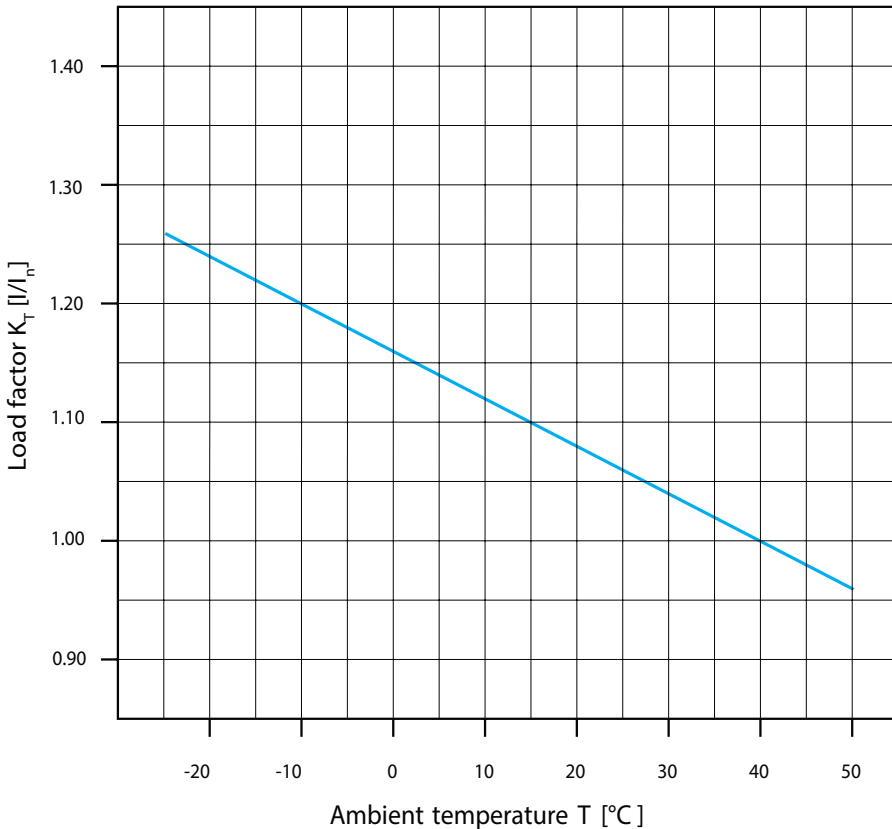

I_L = Maximum Load
 T = Ambient Temperature
 I_N = Rated Current in Amps
 K_T = Load Factor

Maximum load I_L at ambient temperature T:

$$I_L(T) = I_n K_T(T)$$

EATON FAZ-NA Series Accessories

Field Mountable Accessories

- Auxiliary switch
- Alarm switch
- Shunt trip
- No tools required for mounting



ZNHK
Alarm/Aux Contact



ZIHK-NA
Auxiliary Contact

	ZNHK*	ZIHK-NA
Price	\$24.00	\$19.00
Electrical Data		
Contact function	2 Form C (one set changeover) (SPDT)	1 NO + 1 NC (DPST)
Rated voltage	230VAC / 110V AC/DC	600VAC / 230VAC / 120VAC
Frequency	50/60 Hz	
Rated current	2A / 0.5 A	1.2 A / 2A / 6A
Rated thermal current I_{th} 60947-5-1	2A / 250VAC	6A / 250VAC
60947-5-1 Rated operational current I_e	Utilization category AC13	3A / 250VAC
	Utilization category AC15	2A / 250VAC
	Utilization category DC12	0.5 A / 110VDC
Rated insulation voltage U_i	250VAC	
Minimal operational voltage per Contact U_{min}	5VDC	
Minimum operational current I_{min}	10mA DC	10 mA AC/DC
Rated peak withstand voltage U_{imp} (1.2/50μ)	2.5 kV	4kV
Conditional short-circuit current I_k w/ backup fuse 6A	1kA	1kA
Mechanical Data		
Tripping indicator "electrical tripping"	Blue/white	-
Frame size	45mm	
Mounting	Onto FAZ-NA	
Degree of protection, built-in	IP40	
Terminal protection	Finger and hand touch safe according to BGV A3, OVE-EN 6	
Terminals	Lift terminals	
Terminal capacity	20-18 AWG (0.75 - 2.5 mm ²)	20-14 AWG (0.5 - 2.5 mm ²)
Terminal screws	M3 (Posidrive Z0 - Phillips)	
Fastening torque of terminal screws	7 lb-in (0.79 N-m)	Max. 10.6 lb-in (1.2 N-m)

*Voltage of the FAZ-NA circuit breaker is limited to 300V with contact installed.

Allowable Combinations of Accessories

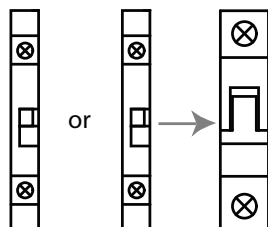

Z-IHK-NA
Standard
Auxiliary

Z-NHK
Auxiliary /
Alarm
Switch

FAZ-NA
Miniature
Circuit
Breaker

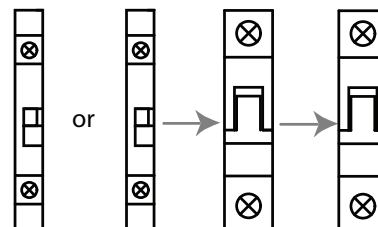

Z-IHK-NA
Standard
Auxiliary

Z-NHK
Auxiliary /
Alarm
Switch

FAZ-XAA-NAxxx
Shunt
Trip

FAZ-NA
Miniature
Circuit
Breaker

EAT•N FAZ-NA Series Accessories

Shunt Trip Release

- Remote release for subsequent mounting onto FAZ-NA
- Additional installation of standard auxiliary switch is possible
- Position indicator red-green



FAZ-XAA-NA Series

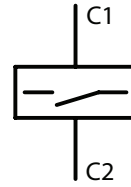

Circuit Diagram

	FAZ-XAA-NA12-110V	FAZ-XAA-NA110-415V
Price	\$35.00	\$35.00
Electrical Data		
Can be mounted onto	FAZ-NA	
Operational voltage range	12-110 VAC 12-60 VDC	110-415 VAC 110-230 VDC
Maximum inrush current	15A	2.1 A
Frequency	50/60 Hz	
Mechanical Data		
Frame size	45mm	
Height	4.13 in (105mm)	
Width	0.69 in (17.5 mm)	
Weight	0.28 lb (127g)	
Mounting	Quick fastening with two lock-in positions on EN 50022	
Degree of protection, built-in	IP40	
Terminal protection	Finger and hand touch safe according to BGV A3, OVE-EN 6	
Terminals	Open mouthed/lift	
Terminal capacity, one and two wires	18-10 AWG (0.8 - 5.3 mm ²)	
Agency Approval	UL File # E257181, CSA 204453	

Note: To obtain the most current agency approval information, see the Agency Approval Checklist section on the specific part number's web page.

Lockout Attachment

Lockout Attachment				
Part Number	Description	Weight	Qty	Price
ZIS-SPE-1TE-3	Lockout attachment for Eaton FAZ-NA series supplementary protectors and FAZ-NA mini circuit breakers, suitable to prevent unauthorized activation of a de-energized circuit, accepts lock shackles up to 9/32 in. (7.1 mm) in diameter	0.10 lb (45g)	3	\$29.50



ZIS-SPE-1TE-3
Lockout Attachment

ZIS-SPE-1TE-3 Installation

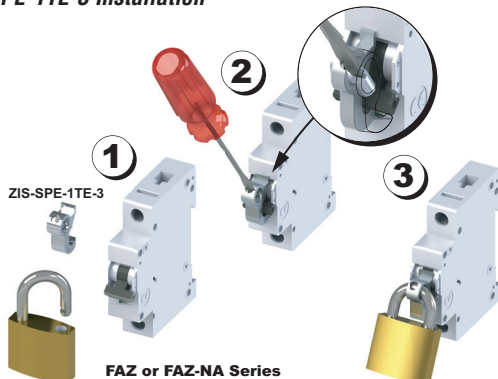

EATON FAZ-NA Series Accessories

Busbar System (Without auxiliary contacts)

Busbar System for FAZ-NA Series Miniature Circuit Breakers		
Part Number	Price	Description
<u>ZSVUL16-1P-1TE6SP</u>	\$10.00	Busbar for connecting up to six (6) 1-pole FAZ-NA series circuit breakers
<u>ZSVUL16-1P-1TE12SP</u>	\$18.00	Busbar for connecting up to twelve (12) 1-pole FAZ-NA series circuit breakers
<u>ZSVUL16-1P-1TE18SP</u>	\$27.50	Busbar for connecting up to eighteen (18) 1-pole FAZ-NA series circuit breakers
<u>ZSVUL16-2P-2TE6SP</u>	\$11.50	Busbar for connecting up to three (3) 2-pole FAZ-NA series circuit breakers
<u>ZSVUL16-2P-2TE12SP</u>	\$22.00	Busbar for connecting up to six (6) 2-pole FAZ-NA series circuit breakers
<u>ZSVUL16-2P-2TE18SP</u>	\$33.00	Busbar for connecting up to nine (9) 2-pole FAZ-NA series circuit breakers
<u>ZSVUL16-3P-3TE6SP</u>	\$12.00	Busbar for connecting up to two (2) 3-pole FAZ-NA series circuit breakers
<u>ZSVUL16-3P-3TE12SP</u>	\$23.00	Busbar for connecting up to four (4) 3-pole FAZ-NA series circuit breakers
<u>ZSVUL16-3P-3TE18SP</u>	\$35.00	Busbar for connecting up to six (6) 3-pole FAZ-NA series circuit breakers

Note: FAZ-NA Busbar is not for use with FAZ supplementary protectors.

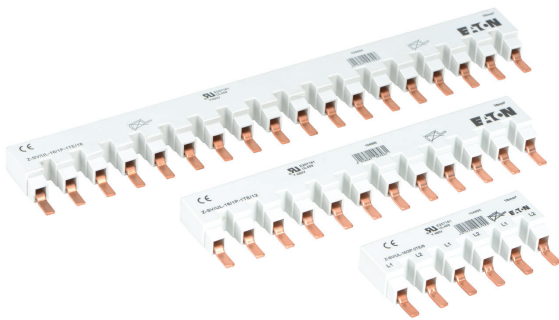

ZSVUL16-xP-xTE_xSP

Busbar Specifications			
Description	UL489		IEC/EN60947-2
Operating Voltage	480VAC	96VDC	240/415 VAC
Frequency	50/60 Hz	n/a	50/60 Hz
Rated Impulse Withstand U_{imp}	n/a		9.5 kV
Max Current - I_c Fed From End	80A @ 40°C		80A @ 30°C
Cross Section	n/a		16 mm ²
Agency Approval	UL File #E257181		

Busbar Connection Diagrams

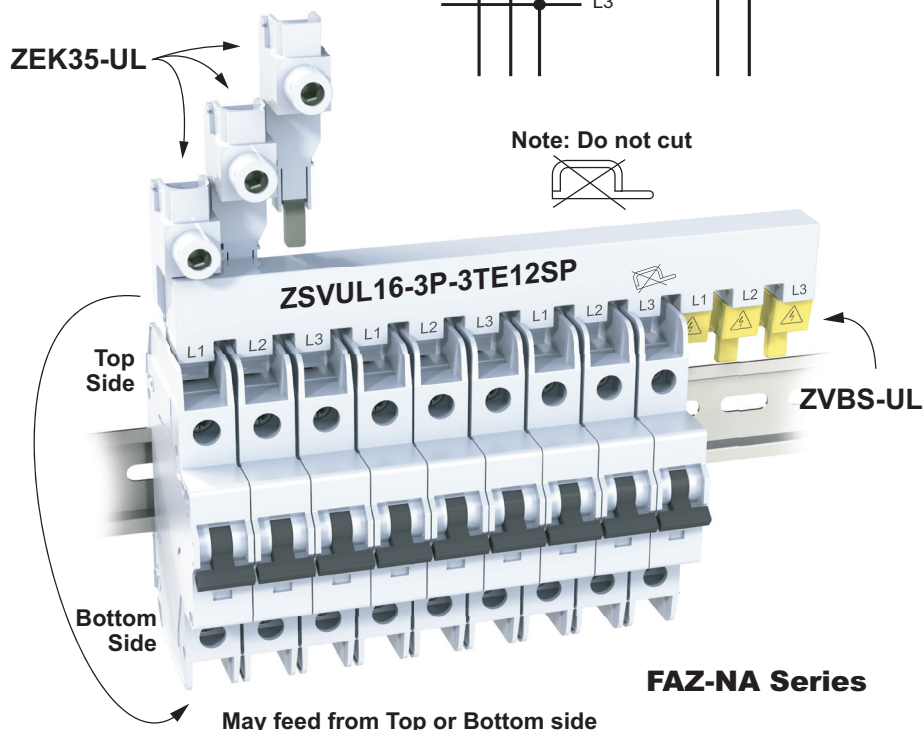
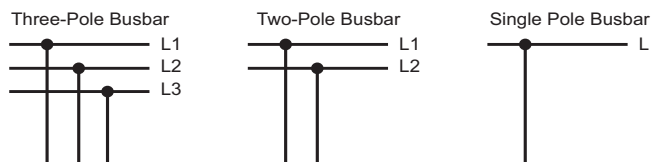

EATON FAZ-NA Series Accessories

Busbar Accessories



Busbar Accessories for FAZ-NA Series Miniature Circuit Breakers		
Part Number	Price	Description
ZVBS-UL	\$25.00	Busbar Shroud - covers for unused bus bar terminals, (10) 3-terminal covers per package
ZVBS-UL-5	\$14.00	Busbar Shroud - covers for unused bus bar terminals, (5) 3-terminal covers per package
ZEK35-UL	\$37.00	Wiring Lug, 2 - 14 AWG (35mm), 3 lugs per package
ZEK35-UL-1	\$13.00	Wiring Lug, 2 - 14 AWG (35mm), 1 lug per package



ZVBS-UL



ZEK35-UL

ZEK35-UL – Specifications			
Description	UL489		IEC/EN60947-2
Operating Voltage	480VAC	96VDC	240/415 VAC
Frequency	50/60 Hz	n/a	50/60 Hz
Rated impulse withstand - U_{imp}	n/a		9.5 kV
Max Current - I_e	80A @ 40°C		80A @ 30°C
	#2 - 14 AWG		2.5 - 35 mm ²
	0.56 in		14mm
Agency Approval	UL File # E307559		

Note: To obtain the most current agency approval information, see the Agency Approval Checklist section on the specific part number's web page.

ZEK35-UL – Tightening Torque		
Tested Acc. To	Cable Size	Tightening Torque
UL 486A	#14 AWG	≥ 20 lb-in (2.3 N-m)
UL 486B	#8 - 12 AWG	≥ 25 lb-in (2.8 N-m)
UL 486E	#6 - 1 AWG	35 lb-in (4 N-m)

EATON FAZ-NA Series Accessories

Accessories Dimensions in [mm]

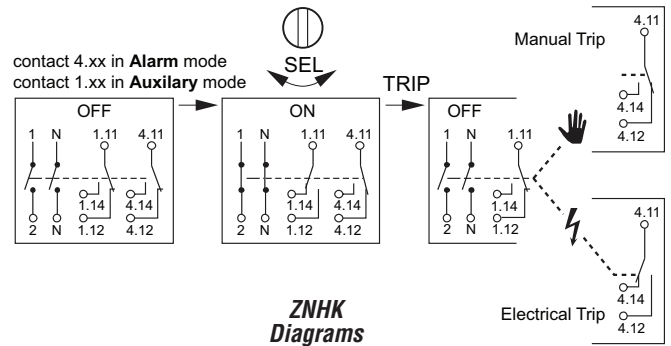
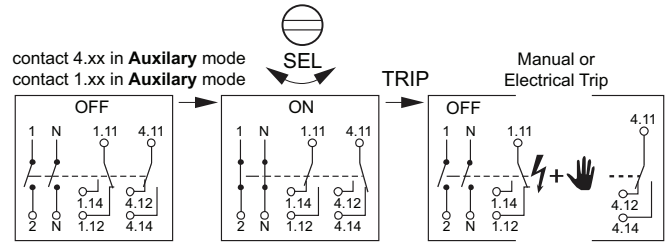
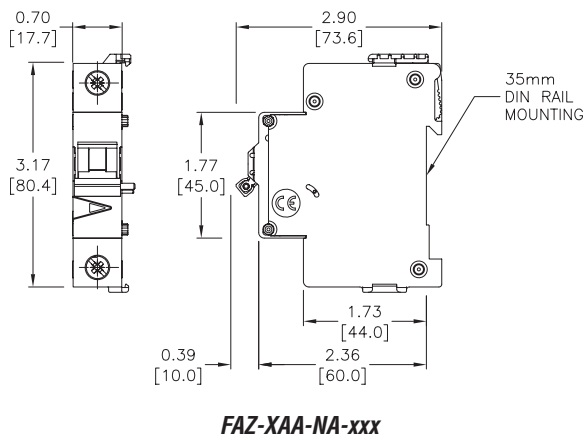
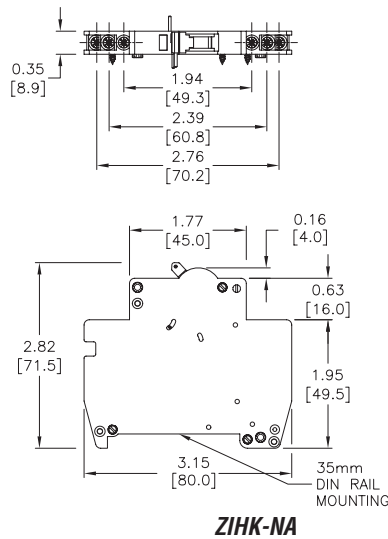
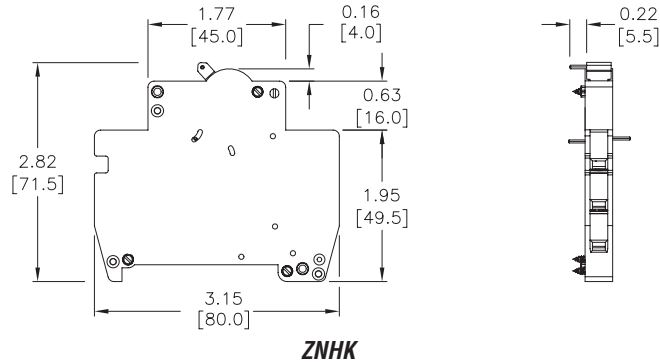
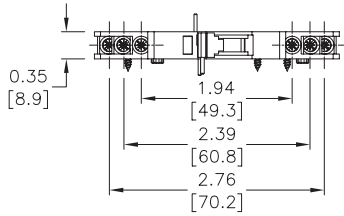

ZNHK Diagrams

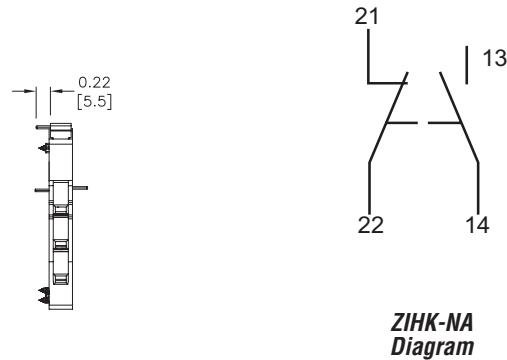

FAZ-NA Series Miniature Circuit Breakers Connection Diagrams

Single Pole

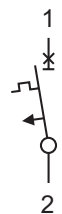

Two-Pole

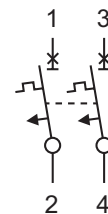

Three-Pole

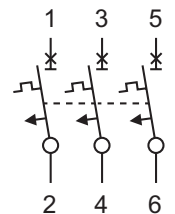

Please see our website www.AutomationDirect.com for complete engineering drawings. Dimensions are approximate. Not for construction purposes.

FAT•N FAZ-NA Series Accessories

Accessories Dimensions in [mm]

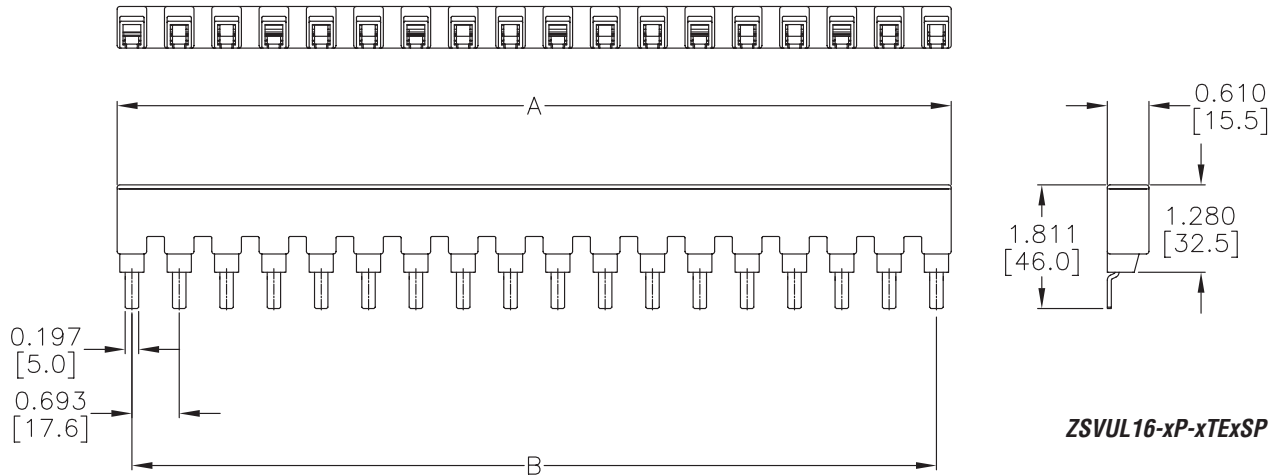

ZSVUL16-xP-xTE6SP

FAZ-NA Busbar Length – in [mm]		
Part Number	A	B
ZSVUL16-xP-xTE6SP	3.90 [99.0]	3.46 [88.0]
ZSVUL16-xP-xTE12SP	8.06 [204.6]	7.62 [193.6]
ZSVUL16-xP-xTE18SP	12.21 [310.2]	11.78 [299.2]

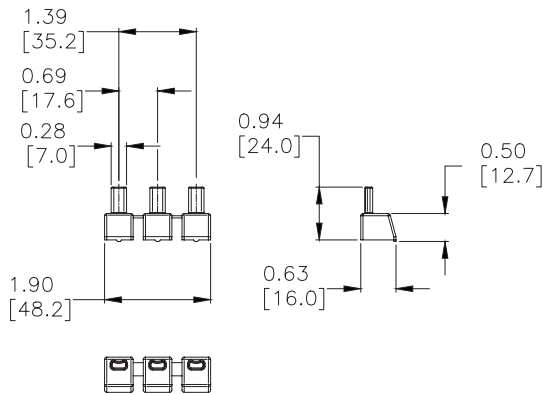

ZVBS-UL

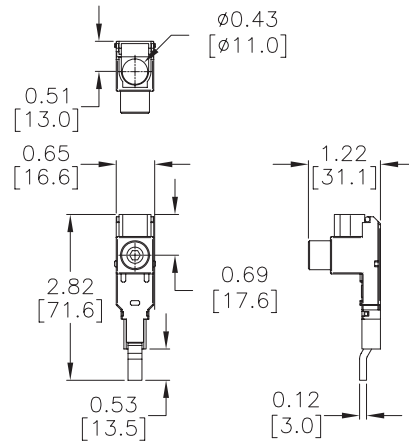

ZEK35-UL

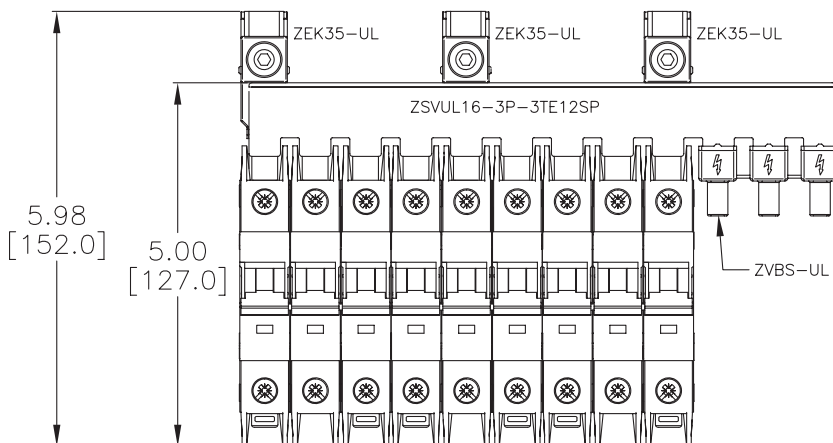

Please see our website www.AutomationDirect.com for complete engineering drawings. Dimensions are approximate. Not for construction purposes.

UL 489 or UL 1077? What are your Circuit Protection Requirements?

An understanding of circuit types and circuit protection products is critical to ensure their proper application.
See NEC Sections 100, 430 and 409 for definitions.

The proper sizing of an overcurrent protection device is the responsibility of the customer and should be determined using the application standards of the NEC (National Electric Code), CEC (Canadian Electrical Code) or other applicable standards. Per fine print note of 2008 NEC Section 100 "A current in excess of rating may be accommodated by certain equipment and conductors for a given set of conditions. Therefore, the rules for overcurrent protection are specific for particular situations."

UL 489

Branch Protection



UL 1077

Supplementary Protection



What You Need to Know and Look For In Specifications

Certifications – Standards – Acceptance

UL 489

Branch Protection

- UL 489 Listed or Recognized
- CSA C22.2 No. 5
- International ratings available depending on breaker type

UL 1077

Supplementary Protection

- UL Recognized under UL 1077
- CSA 22.2 No. 285
- IEC 60947-2 or IEC 898

Function

- | | |
|--|---|
| <ul style="list-style-type: none"> • Opens automatically on Overload and Short Circuit when properly applied within its ratings • Protects wire and cable against Overload and Short Circuit | <ul style="list-style-type: none"> • Opens automatically on Overload and Short Circuit • Provides additional equipment protection where branch circuit protection is already provided or not required • Not suitable for the protection of branch circuit conductors |
|--|---|

Applications

- | | |
|---|---|
| <ul style="list-style-type: none"> • Branch circuit protection in control panels, panelboards, switchboards and motor control centers • Motor overload and motor short circuit protection (UL 489 Recognized motor circuit protectors) for control panels and motor control centers | <ul style="list-style-type: none"> • Used within appliances or other electrical equipment such as control circuits, control power transformers, relays, PLC I/O points and lighting circuits • Ideal replacement for fuses that are applied as supplementary protection |
|---|---|

Features

- | | |
|--|---|
| <ul style="list-style-type: none"> • Bolted down or DIN rail mounted • External handle mechanisms available • Field mounted accessories • Stand alone branch circuit protection • Various levels of protection (curve type) • High voltage and interruption levels (up to 100 kAIC @ 480V) | <ul style="list-style-type: none"> • DIN rail mounted • Field mounted accessories • Various levels of protection (curve type) • 10 kAIC @ 240 VAC • 10 kAIC @ 277 VAC and 5 kAIC @ 480VAC • 10 kAIC @ 48VDC |
|--|---|

KAIC = thousands of Amps interrupt capacity

Summary

A Supplementary Protector can't be used for Branch Circuit Protection.
Understanding the difference between Branch Circuit Protection and Supplementary Protection helps to ensure their proper use.

UL 1077 Supplementary Protectors and UL 489 Circuit Breakers Application Guidelines

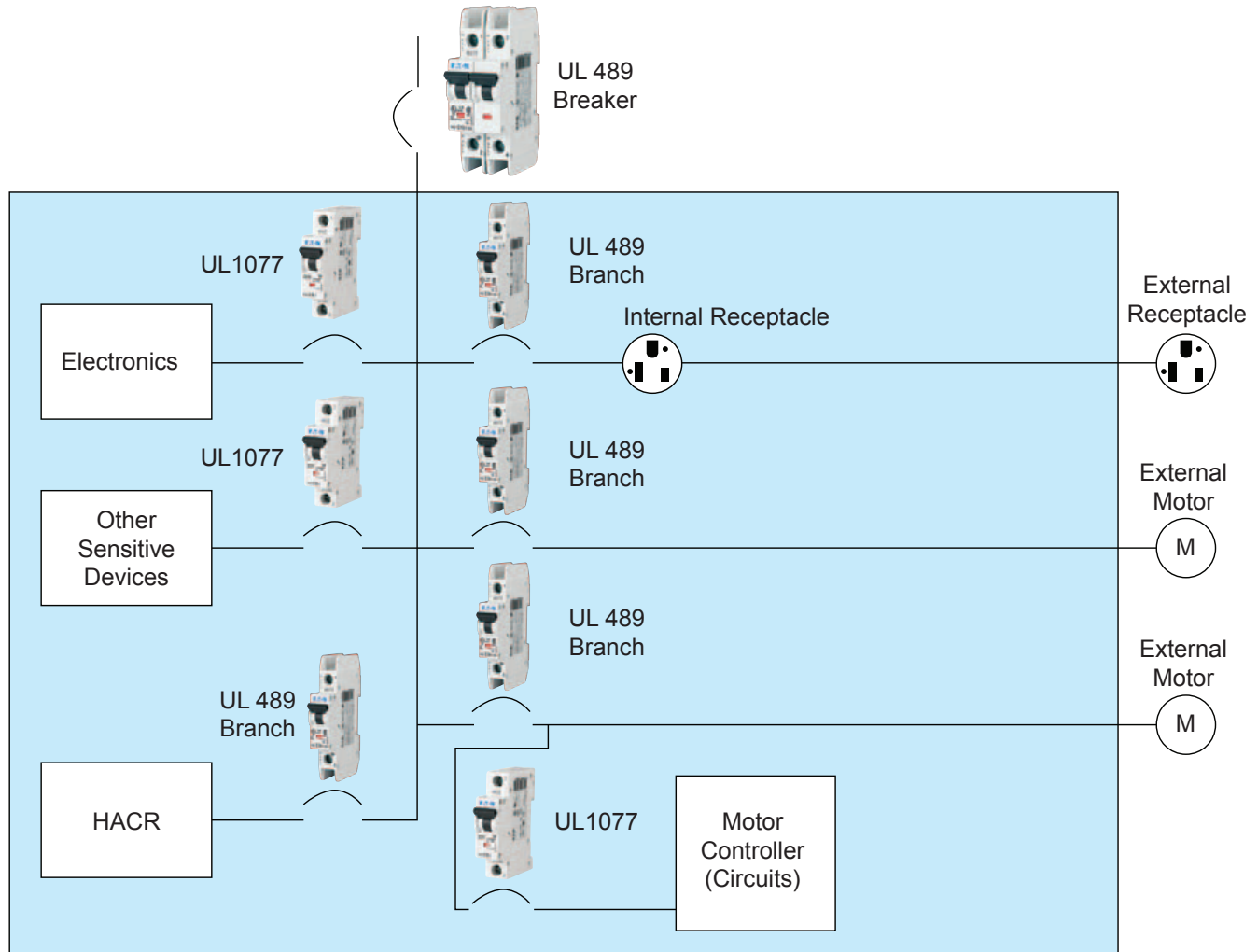

Example of UL 489 and UL 1077 Application

UL489 circuit breakers

Used for branch circuit protection, internal/external receptacles, external motors and HACR equipment (heating, air conditioning and refrigeration).

UL1077 supplementary protectors

Used for overcurrent protection within appliances or electrical equipment, where branch circuit protection is already provided or not required.

Note: UL489 devices can be used in place of UL1077; UL1077 devices cannot be used in place of UL489.