

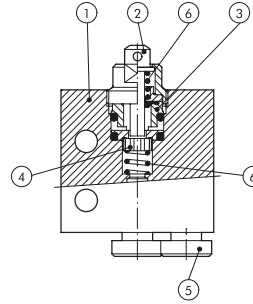

Pneumatic Manual Valves

Pneumatic Manual Valve Materials

1. Aluminum valve body
2. Chemically nickel-plated brass button
3. Brass distance plates
4. NBR gaskets
5. Stainless steel, brass and plastic push-to-connect cartridges
6. Stainless steel springs



Pneumatic Metal Plunger Valves

These pneumatic valves are used with Nitra pneumatic pushbuttons and switches

Features

- Available in normally open or normally closed
- 5/32" [4mm] push-to-connect ports located on side or end

Valve Symbols

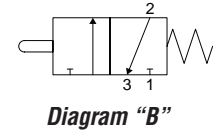
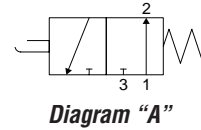

EVP-CA-PL



EVP-CS-PL

Specifications				
Models	<i>EVP-CA-PL</i>	<i>EVP-AA-PL</i>	<i>EVP-CS-PL</i>	<i>EVP-AS-PL</i>
Price	\$19.00	\$21.00	\$17.50	\$19.00
Weight (lbs)	0.1	0.1	0.1	0.1
Valve Type	2-port (3-way) 2-position			
Acting	Metal plunger, normally closed, spring return	Metal plunger, normally open, spring return	Metal plunger, normally closed, spring return	Metal plunger, normally open, spring return
Diagram	B	A	B	A
Port Size	Axial ports 5/32in (4mm)		Side ports 5/32in (4mm)	
Flow (Cv)	0.13	0.13	0.13	0.13
Fluid	Air (to be filtered by 40µ filter element)			
Min. / Max. Pressure	7.25 to 145 psi (0.5 to 10 bar)			
Temperature	14°F to 140°F (-10°C to 60°C)			
Lubrication	Not Required			
Body	Aluminum			
Protection	IP65			

Dimensions mm [inches]

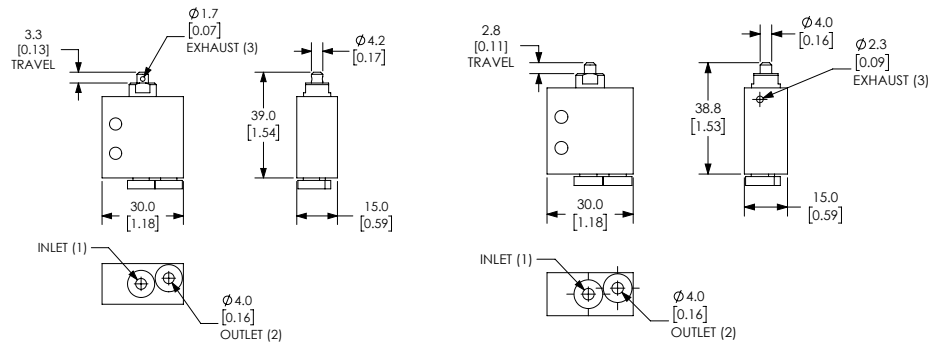

EVP-CA-PL

EVP-AA-PL

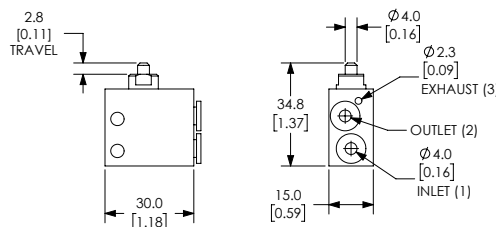

EVP-CS-PL / EVP-AS-PL

See our website www.AutomationDirect.com for complete Engineering drawings.



Pneumatic Pushbuttons, 22mm

NITRA® pneumatic pushbuttons are all plastic and come with adapters to allow mounting of up to two 3-way valves, or one valve and one to three contact blocks. They fit in a standard 22.5mm hole, just like electrical pushbuttons.

Features

- Plastic bezel and button
- Valve adapters and mounting screws included
- Valves sold separately
- Bases will work with GCX plastic operators and **only** the three ECX Series contact blocks shown below



Pushbutton Specifications	
Operating Temperature	-13 to 158°F (-25 to +70°C)
Storage Temperature	-40 to 176°F (-40 to +80°C)
Mechanical Life	1,000,000 cycles
Switching Cycles	3600 cycles/hr
Mounting (Valve)	(4) M3x5 valve mounting screws included
Protection	IP65 after installation
Approvals	CE

Adapter Block Installation

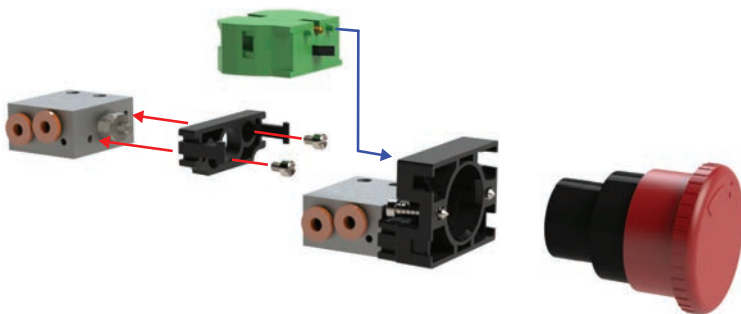
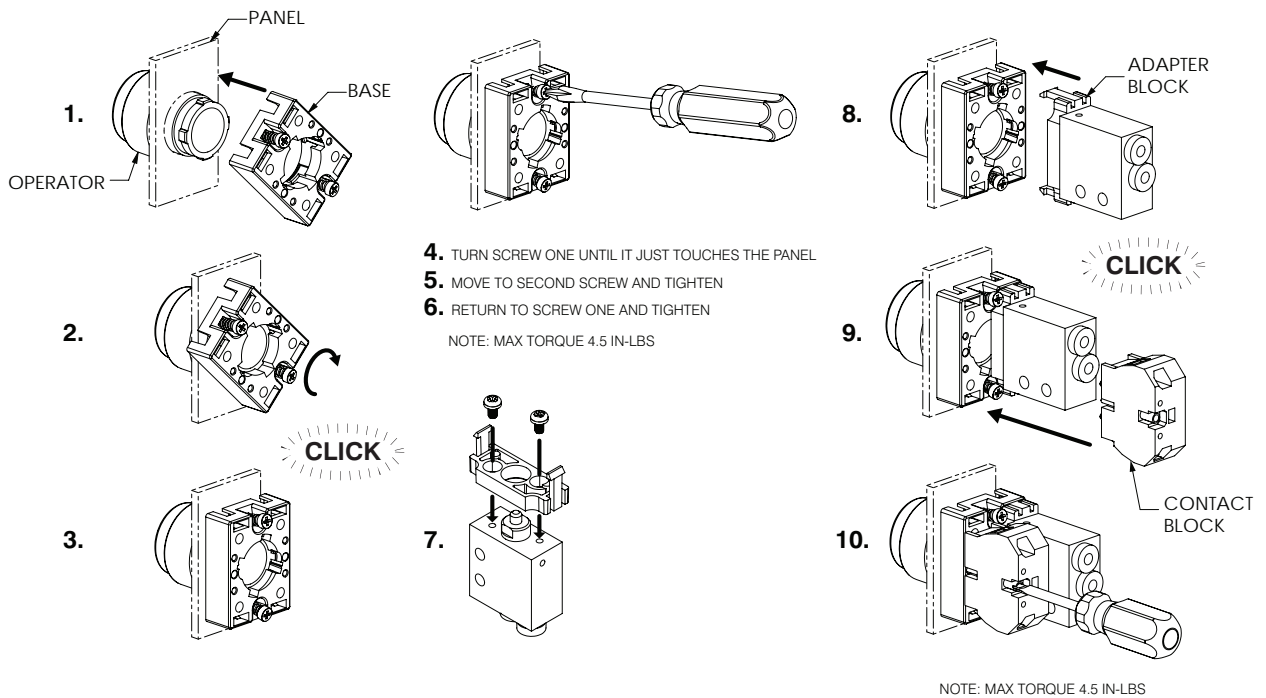

ECX1040-2



ECX1042-2



ECX1030-2