



SIRCOVER UL 1008

Manual Transfer Switching Equipment

The solution for manufacturing, power distribution and domestic applications

Functions

The Socomec SIRCOVER family of switches are manual transfer switches rated UL 1008. These switches are extremely durable and are tested and approved for use in the most demanding applications, such as resistive load or total system applications.

Applications

- Normal power supply to generator transfer
- Bypass operations
- Changing motor phase for rotation control or equipment grounding

Advantages

Stable positions

SIRCOVERs have three stable, completely isolated positions that are not affected by voltage drops or mechanical vibrations. This safety feature eliminates the risk of short-circuiting between two unsynchronized power supplies, even during transient events.

Compact design

The SIRCOVER is based on back-to-back switching technology, providing a compact solution.

Reliability

The SIRCOVER has double breaking per pole achieved through its sliding bar contacts system.

The quick opening and rapid closure provides simultaneous disconnecting or making of all power contacts.



Sircover M UL 1008 Manual Transfer Switching Equipment



To assemble a switch, please select:

Direct Operation

External Operation



+

OR



+

+



Switch Body

Direct Handle

Switch Body

Shaft

External Handle

UL 1008 Manual Transfer Switching Equipment				
Part Number	Poles	Amp Rating	Max Operation Voltage (AC)	Price
41502012	2	100	240VAC	\$313.00
41503012	3		600VAC	\$367.00
41504012	4		600VAC	\$468.00
41502026	2	260	240VAC	\$604.00
41503026	3		600VAC	\$739.00
41504026	4		600VAC	\$982.00
41503042	3	400	600VAC	\$864.00
41504042	4			\$1,180.00



41503012

Note: Not to be used as motor disconnect. MTS meets the requirements of NEC section 702.2.

Direct Handle						
Part Number	Description	Switch Body Rating (A)	Handle Color	Handle Type	NEMA / UL Type	Price
41994012	B type handle for direct operation. Lockable in positions I and II.	100 - 400	Black	B3	-	\$29.50



Direct Handle

41994012

External Handles						
Part Number	Switch Body Rating (A)	Handle Color	Handle Type	NEMA / UL Type	Lockable in 3 positions	Price
142D2113	100 - 200	Black / Blue	S2	4, 4X	No	\$48.00
142E2113		Red / Yellow				\$48.00
142F2113		Black / Blue		1, 3R, 12		\$44.50
142G2113		Red / Yellow				\$44.50
142D2813		Black / Blue	S3	4, 4X	Yes	\$49.50
142E2813		Red / Yellow				\$49.50
142F2813		Black / Blue		1, 3R, 12		\$44.50
142G2813		Red / Yellow				\$44.50
143D3113	260 - 600	Black / Blue	S3	4, 4X	No	\$52.00
143E3113		Red / Yellow				\$52.00
143F3113		Black / Blue		1, 3R, 12		\$53.00
143G3113		Red / Yellow				\$53.00
143D3813		Black / Blue	S3	4, 4X	Yes	\$52.00
143E3813		Red / Yellow				\$52.00
143F3813		Black / Blue		1, 3R, 12		\$52.00
143G3813		Red / Yellow				\$52.00



S2 Type

142D2113



S3 Type

143D3113

Sircover UL 1008 Manual Transfer Switching Equipment



Shaft for External Handle

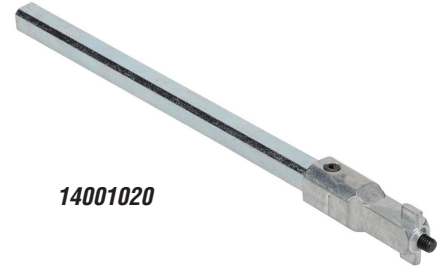

14001020

Bridging Bars



41593021

Auxiliary contacts



41590021

Terminal Protection Screens



41583021

Shafts for External Handles				
Part Number	Switch Body Rating (A)	Handle Type	Length (in / mm)	Price
14001020	30-400	S1, S2	7.9 / 200	\$9.25
14001032			12.6 / 320	\$10.00
14001040			15.7 / 400	\$11.50
14011520	600	S3	7.9 / 200	\$12.50
14011532			12.6 / 320	\$16.50
14011540			15.7 / 400	\$18.00

Bridging Bars				
Part Number	Description	Switch Body Rating (A)	QTY	Price
41592021	Allows creation of a common point, above or below the switch, between positions I and II for line or load side connections.	100 - 200	2 bridging bars	\$69.00
41593021			3 bridging bars	\$94.00
41594021			4 bridging bars	\$118.00
41592041		260 - 400	2 bridging bars	\$73.00
41593041			3 bridging bars	\$110.00
41594041			4 bridging bars	\$160.00

Auxiliary Contacts				
Part Number	Description	Switch Body Rating (A)	Contacts	Price
41590021	Auxiliary contact, side mount, 10A @ 125VAC/250VAC. Package of 2.	100 - 400	NO/NC on position I and II	\$12.00
41590022	Auxiliary contact, side mount, 1A @ 125VAC, low impedance. Package of 2.	100 - 400	Low level NO/NC on position I and II	\$18.00

Terminal Protection Screens				
Part Number	Description	Switch Body Rating (A)	Number of poles	Price
41583021*	Use for top or bottom protection against direct contact with terminals or connecting parts.	100 - 200	2/3 P	\$16.50
41584021*		100 - 200	4 P	\$24.50
41583041		260 - 400	2/3 P	\$22.50
41584041		260 - 400	4 P	\$26.50

* Note: Screen covers line AND load terminals

Terminal Lugs							
Part Number	Description	Switch Body Rating (A)	Wires	Wires range	Lugs per kit	Wires per lug	Price
39542020	Kit of terminal lugs for connection of bare copper cables onto the terminals (without lugs).	200	Cu/Al	#6 - 300MCM	2	1	\$14.00
39542040		260-400		#4 - 600MCM	2		\$44.00
39543020		200		#6 - 300MCM	3		\$20.50
39543040		400		#2 - 600MCM	3		\$53.00
39544020		200		#6 - 300MCM	4		\$27.00
39544040		260-400		#4 - 600MCM	4		\$86.00



39542040

Sircover M UL 1008 Manual Transfer Switching Equipment



Technical Characteristics

Characteristics According to UL 1008			
	41502012 41503012 41504012	41502026 41503026 41504026	41503042 41504042
General use rating	100A	260A	400A
Operation voltage 2 P / 3-4 P	240 / 600	240 / 600	240 / 600
Short-circuit rating with any breaker (kA) / Short-circuit capacity (ms)	10 / 25	14 / 50	14 / 50
Short-circuit rating at 600 VAC (kA)	100	65	65
Type of fuse	J	J	J
Max. fuse rating (A)	200	600	600
Short-circuit rating with specific breaker (kA)			
Square D JJ breaker 250 A 2 poles 240 VAC / 3-4 poles 480 VAC	65	-	-
Schneider Electric NSX-F 160 A 3-4 poles 480 VAC	35	-	-
Operational power / current max Operational 1 ph			
240 VAC total system (A)	100	260	400
240 VAC resistive load (A)	100	260	400
Operational power / current max Operational 3 ph			
240 VAC total system (A)	100	260	400
240 VAC resistive load (A)	100	260	400
480 VAC total system (A)	100	260	400
480 VAC resistive load (A)	100	260	400
600 VAC total system (A)	100	200	200
600 VAC resistive load (A)	100	260	400
Mechanical endurance			
Endurance (number of operating cycles)	6050	6050	4050
Connection terminals			
Min. connection section / AWG	#6	#4 / 2x1 / 0	#4 / 2x1 / 0
Max. connection section / AWG	300MCM	600MCM / 2 x 250MCM	600MCM / 2 x 250MCM
Agency approvals			
UL file # E173959, CSA file # 112964, CE 2011/65/EU, 2014/35/EU LVD, and 2014/30/EU EMC			

Mounting orientation (100 to 400 A)

Ensure that the product is installed on a flat rigid surface

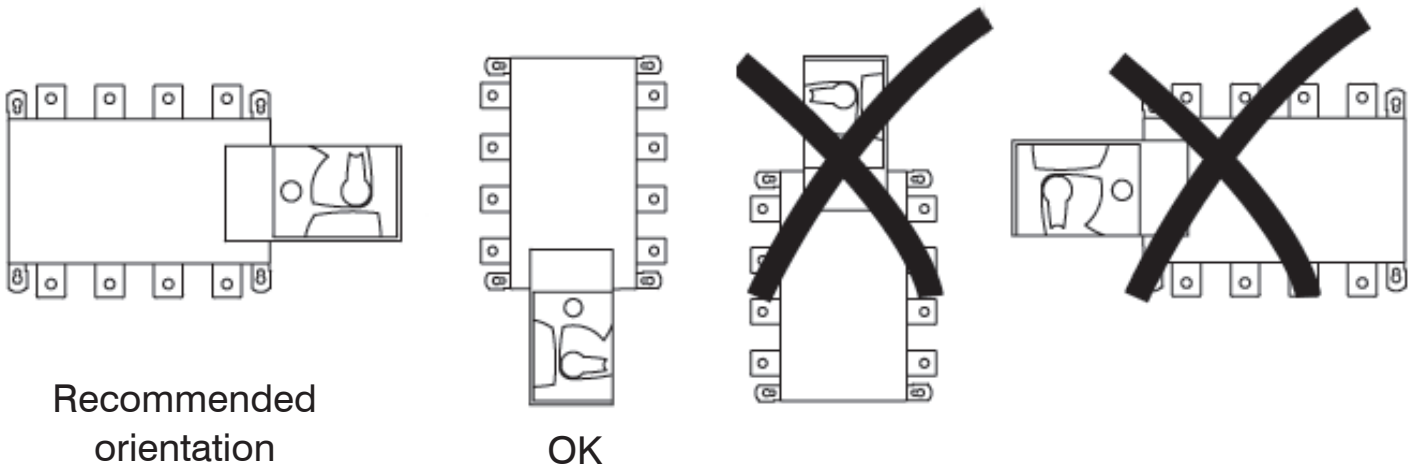

Sircover M UL 1008 Manual Transfer Switching Equipment



Dimensions Inches [mm]

External Handles for UL 1008 Manual Transfer Switches		
S2 Handle		
<p>Handle Dimensions</p>	<p>Direction of Operation</p>	<p>Door Drilling</p>
S3 Handle		
<p>Handle Dimensions</p>	<p>Direction of Operation</p>	<p>Door Drilling</p>

Shaft Length Minimum Dimensions						
Switch Body Rating (A)	Dimension X		Handle Type	Length		Part Number
	in	mm		in	mm	
100 - 200	10-14.3	254-362	S2	7.9	200	14001020
	10-19	254-482		12.6	320	14001032
	10-22.1	254-562		15.7	400	14001040
260-400	20-23.4	508-594	S3	7.9	200	14011520
	20-28.1	508-714		12.6	320	14011532
	20-31.3	508-794		15.7	400	14011540

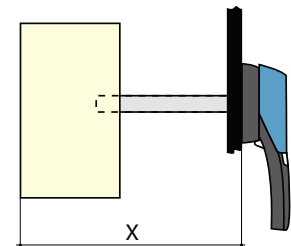

Please see our website www.AutomationDirect.com for complete engineering drawings.

Sircover M UL 1008 Manual Transfer Switching Equipment



Dimensions

Inches [mm]

Direct Handle

41994012

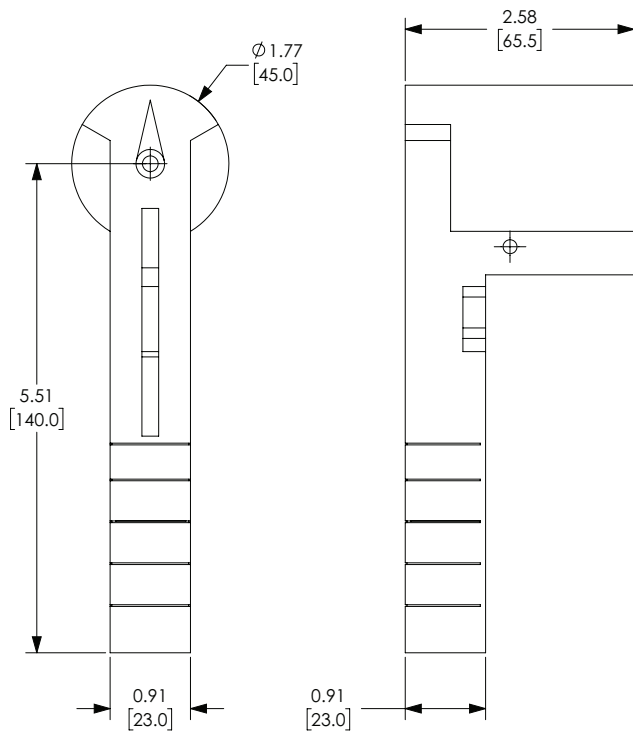

Bridging Bars

41592021 (100-200 A)

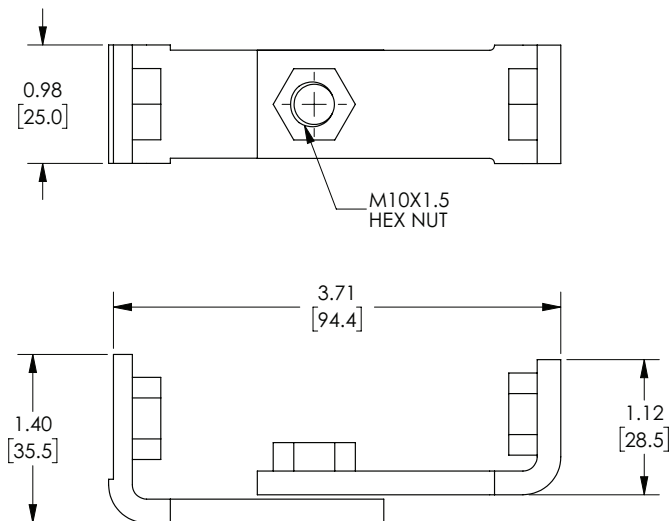

41592041 (260-400 A)

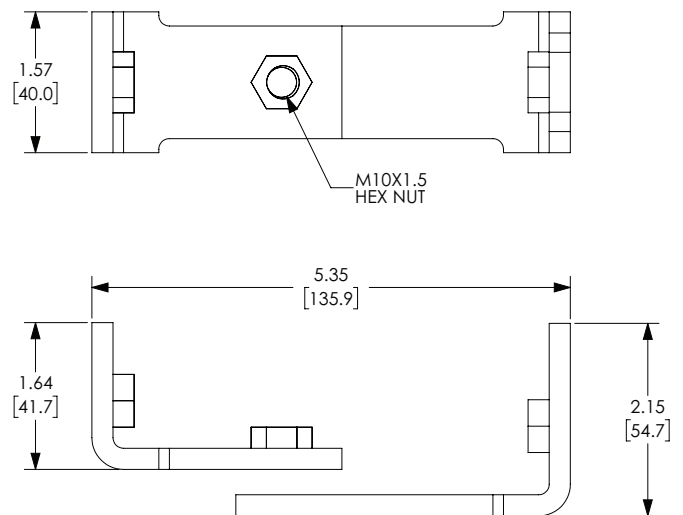

Terminal Lugs

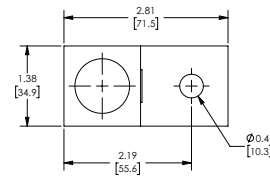

39542040



39542020
39543020
39544020

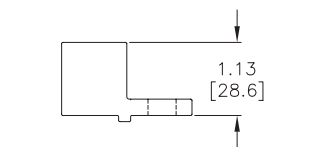
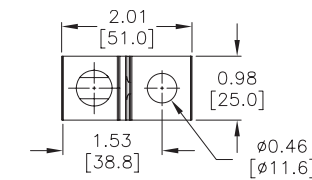

39544040

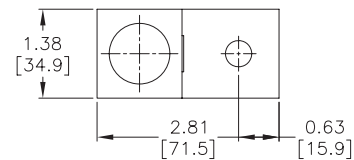

Please see our website www.AutomationDirect.com for complete engineering drawings.

Sircover M UL 1008 Manual Transfer Switching Equipment



Dimensions (see table at bottom of page)

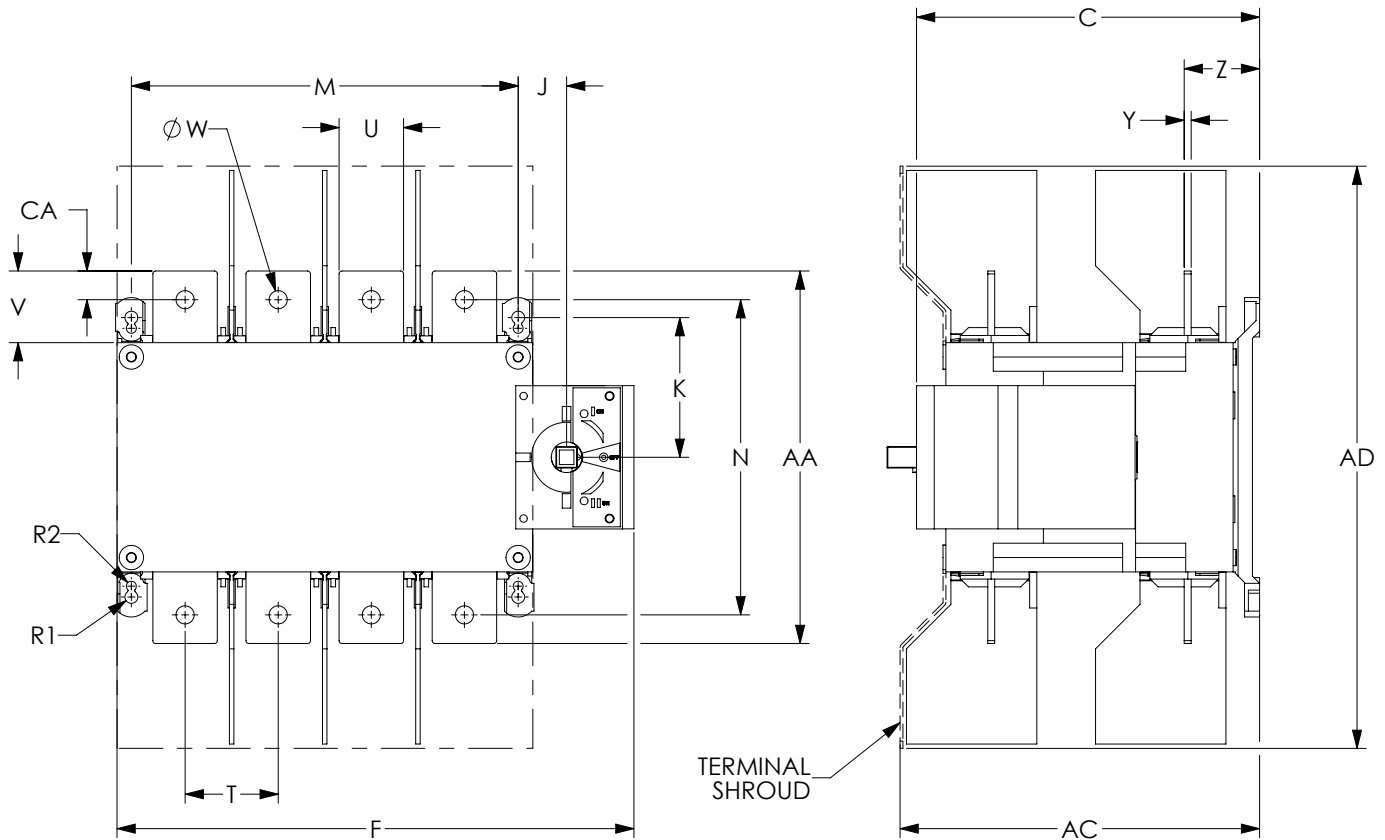

Dimensions Inches [mm]																							
Part Number	Body Rating	C	AC	AD	F 2p	F 3p	F 4p	J	K	M 2p	M 3p	M 4p	N	R1	R2	T	U	V	W	Y	Z	AA	CA
41502012	100A	6.42	6.93	10.43	9.61	9.61	11.57	1.38	3.84	6.30	6.30	8.27	7.68	0.18	0.14	1.97	0.98	1.18	0.43	0.14	1.55	6.30	0.56
41503012		[163]	[176]	[265]	[244]	[244]	[294]	[35]	[98]	[160]	[160]	[210]	[195]	[5]	[4]	[50]	[25]	[30]	[11]	[4]	[39]	[160]	[14]
41504012																							
41502026	260A	9.43	6.52	15.98	11.84	11.84	14.19	1.33	3.84	8.27	8.27	10.63	7.68	0.18	0.14	2.56	1.77	1.97	0.50	0.19	2.07	10.24	0.79
41503026		[240]	[166]	[406]	[301]	[301]	[360]	[34]	[98]	[210]	[210]	[270]	[195]	[5]	[4]	[65]	[45]	[50]	[13]	[5]	[53]	[260]	[20]
41504026																							
41503042	400A	9.43	6.52	15.98	-	11.84	14.19	1.33	3.84	-	8.27	10.63	7.68	0.18	0.14	2.56	1.77	1.97	0.50	0.19	2.07	10.24	0.79
41504042		[240]	[166]	[406]		[301]	[360]	[34]	[98]		[210]	[270]	[195]	[5]	[4]	[65]	[45]	[50]	[13]	[5]	[53]	[260]	[20]

Please see our website www.AutomationDirect.com for complete engineering drawings.